



Frontek

INTELLIGENT EXTRUSION





Hemos creado una gama especial con producto porcelánico de calidad, para que sus proyectos destaquen en innovación y durabilidad, todo ello con la garantía y experiencia de una empresa de reconocido prestigio internacional.

We have created a special range with quality porcelain products, so that your projects stand out in innovation and durability, all with the guarantee and experience of a company of recognized international prestige.

Nous avons créé une gamme spéciale de produits en porcelaine de qualité, afin que vos projets se distinguent en termes d'innovation et de durabilité, tout en bénéficiant de la garantie et de l'expérience d'une entreprise au prestige international reconnu.

Frontek

SUSTAINABILITY

SOSTENIBILIDAD | DURABILITÉ

Compromiso | Commitment | Engagement

En **Grupo Greco Gres** llevamos varios años transformando nuestros hábitos y procesos productivos para **minimizar el impacto** de nuestra actividad sobre el planeta. Tenemos un **compromiso firme**, no sólo con la emisión mínima de CO₂ a la atmósfera, sino con una contribución cada vez mayor a la **sostenibilidad** y a la **economía circular** con una mejora constante de nuestras materias y procesos, mediante la utilización de **energías renovables**.

At **Grupo Greco Gres** we have spent several years transforming our habits and production processes to **minimize the impact** of our activity on the planet, we have a **firm commitment**, not only with the minimum emission of CO₂ into the atmosphere, but with a growing contribution to **sustainability** and **circular economy** with a constant improvement of our materials and processes, through the use of **renewable energies**.

Au **Grupo Greco Gres**, nous avons passé plusieurs années à transformer nos habitudes et nos processus de production afin de **minimiser l'impact** de notre activité sur la planète. Nous sommes **fermement engagés**, non seulement à minimiser l'émission de CO₂ dans l'atmosphère, mais aussi à contribuer de plus en plus à la **durabilité** et à l'**économie circulaire** avec une amélioration constante de nos matériaux et de nos processus, grâce à l'utilisation d'**énergies renouvelables**.

Emisiones mínimas | Minimum emissions | Émissions minimales

Gracias a la optimización del consumo de energía y a los cambios implementados, hemos podido **reducir nuestra huella de carbono** y, por tanto, el impacto de nuestra actividad sobre el medio ambiente. Cumplimos **auditorías** anuales que miden y controlan nuestras emisiones de gases y CO₂ a la atmósfera y que certifican que nuestros residuos **no causan impactos** a nivel global en el planeta ni en la salud de las personas.

Thanks to the optimization of energy consumption and the changes implemented, we have been able to **reduce our carbon footprint** and, therefore, the impact of our activity on the environment. We comply with annual **audits** that measure and control our gas and CO₂ emissions into the atmosphere and certify that our waste **does not cause global impacts** on the planet or on people's health.

Grâce à l'optimisation de la consommation d'énergie et aux changements mis en œuvre, nous avons pu **réduire notre empreinte carbone** et donc l'impact de notre activité sur l'environnement. Nous nous soumettons à des **audits** annuels qui mesurent et contrôlent nos émissions de gaz et de CO₂ dans l'atmosphère et certifient que nos déchets **n'ont pas d'impact global** sur la planète et sur la santé des personnes.

Planta fotovoltaica | Photovoltaic plant | Centrale photovoltaïque

Nos autoabastecemos con nuestra planta fotovoltaica de **más de 30.000 m²** y **5.500 placas dobles**, que nos permiten un **ahorro** en electricidad de **hasta el 40%**.

We are self-sufficient with our photovoltaic plant of more than 30,000 m² and 5,500 double panels, which allow us to save up to 40% in electricity.

Nous sommes autosuffisants avec notre centrale photovoltaïque de plus de 30 000 m² et 5 500 doubles panneaux, ce qui nous permet d'**économiser jusqu'à 40 %** d'électricité.



Reutilización del agua | Water reuse | Réutilisation de l'eau

Con un uso eficiente del agua, mediante **circuito cerrado** y la **rectificación de las piezas en seco**, hemos conseguido una **reducción significativa** de su consumo.

With an efficient use of water, by means of a **closed circuit** and **dry grinding of the parts**, we have achieved a **significant reduction** in water consumption.

Grâce à une utilisation efficace de l'eau, au moyen d'un **circuit fermé** et d'un **broyage à sec des pièces**, nous sommes parvenus à une **réduction significative** de la consommation d'eau.

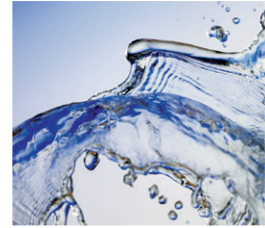

Reciclaje | Recycling | Recyclage

Gracias a nuestras arcillas 100% naturales y sin aditivos, podemos **reciclar hasta un 11%** de material sin cocer con el proceso de **reciclaje integrado** en nuestras líneas de producción.

Thanks to our 100% natural and additive-free clays, we can recycle up to 11% of unfired material with the recycling process integrated into our production lines.

Grâce à nos argiles 100% naturelles et sans additifs, nous pouvons recycler jusqu'à 11% des matériaux non cuits avec le processus de recyclage intégré dans nos lignes de production.



Certificación LEED | LEED certification | Certification LEED

Es un sistema de **certificación con reconocimiento internacional** para edificios sostenibles creado por el Consejo de Edificación Sostenible de Estados Unidos. La certificación evalúa distintos parámetros clasificados en 9 categorías y permiten obtener **un máximo de 110 puntos LEED**.

Is an **internationally recognized certification system** for sustainable buildings created by the U.S. Sustainable Building Council. The certification evaluates different parameters classified in 9 categories and allows obtaining a maximum of 110 LEED points.

Est un **système de certification internationalement reconnu** pour les bâtiments durables, créé par le US Sustainable Building Council. La certification évalue différents paramètres classés en 9 catégories et permet d'obtenir un maximum de 110 points LEED.

El sistema de fachada ventilada Frontek contribuye a obtener hasta 41 puntos LEED en las siguientes categorías:

The Frontek ventilated facade system contributes up to 41 LEED points in the following categories:

Le système de façade ventilée Frontek apporte jusqu'à 41 points LEED dans les catégories suivantes :

| Proceso integrador Processus d'intégration Integration process | Materiales y recursos Materials and resources Matériels et ressources | Calidad ambiental interior Indoor environmental quality Qualité de l'environnement intérieur |
|--|--|--|
| 1 pt | hasta 18 pt | hasta 4 pt |
| Energía y atmósfera Energy and atmosphere Énergie et atmosphère | Reducción del impacto del ciclo de vida del edificio Building life-cycle impact reduction Réduire l'impact du cycle de vie du bâtiment | Materiales de baja emisión Low-emission materials Matériaux à faibles émissions |
| | Declaraciones ambientales de producto Environmental product declarations Déclarations environnementales de produits | Confort térmico Thermal comfort Confort thermique |
| Optimización rendimiento energético Optimize energy performance Optimisation de l'efficacité énergétique | Fuentes de materias primas Sourcing of raw materials Sources de matières premières | Innovación Innovation L'innovation |
| LEED v4 GRECO GRES | Componentes de los materiales Material ingredients Composants matériels | hasta 5 pt |
| | Gestión de residuos de construcción y demolición Construction and demolition waste management Gestion des déchets de construction et de démolition | Innovación Innovation L'innovation |



SUSTAINABILITY

SOSTENIBILIDAD | DURABILITÉ

El principal producto de Grupo Greco Gres, la **fachada ventilada** porcelánica, permite **construcciones sostenibles** y dota a los edificios de una gran **eficiencia energética**.

Grupo Greco Gres' main product, the porcelain **ventilated façade**, allows for **sustainable construction** and provides buildings with high **energy efficiency**.

Le principal produit du Grupo Greco Gres, la **façade ventilée** en porcelaine, permet la **construction durable** et rend les bâtiments très **efficaces sur le plan énergétique**.



Los últimos avances tecnológicos permiten la fabricación de Frontek, unas piezas de **porcelánico por extrusión** que poseen una gran dureza, ligereza y resistencia, **ideales para el revestimiento de fachadas**. Su exclusivo sistema alveolar caracteriza la colección, dotando a las piezas de una firme estructura al mismo tiempo que se reduce notablemente su peso.

Frontek cuenta con un excelente comportamiento ante los agentes climáticos y medioambientales, convirtiéndolo en una **elección idónea para recubrimiento de edificios**.

Disponibile en una gran **gama de tonalidades y texturas**, que requieren un bajo mantenimiento y son resistentes a la abrasión, las rayaduras y las manchas.

The latest technological advances permit the manufacture of Frontek, **extruded porcelain** pieces that are extremely hard, light and resistant, **ideal for façade cladding**. Its exclusive honeycomb system characterises the collection, giving the pieces a firm structure while significantly reducing their weight.

Frontek has a excellent behaviour in the face of climatic and environmental agents, making it an **ideal choice for building cladding**.

We offer a wide **range of shades and textures**, which require low maintenance and are resistant to abrasion, scratches and stains.

Les dernières avancées technologiques permettent la fabrication de Frontek, des pièces de **porcelaine extrudée** extrêmement dures, légères et résistantes, **idéales pour le revêtement des façades**. Son système exclusif de alvéolaires caractérise la collection, conférant aux pièces une structure solide tout en réduisant considérablement leur poids.

Frontek présente d'excellentes performances climatiques et environnementales, ce qui en fait un **choix idéal pour le revêtement des bâtiments**.

Nous proposons une large **gamme de teintes et de textures**, qui nécessitent peu d'entretien et résistent à l'abrasion, aux rayures et aux taches.

VENTILATED FACADE

FACHADA VENTILADA | FAÇADE VENTILÉE

El uso de la pieza Frontek **con su exclusivo sistema alveolar** proporciona numerosas ventajas.



Eficiencia energética

Energy efficiency | Efficacité énergétique



Aislamiento térmico y acústico

Thermal and acoustic insulation | Isolation thermique et acoustique



Ligereza y durabilidad

Lightness and durability | Légèreté et durabilité

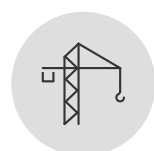

Instalación rápida y sencilla

Quick and easy install | Installation rapide et facile



Mínima absorción del agua

Minimal water absorption | Prélèvement minimal d'eau



No precisa mantenimiento

No maintenance required | Sans maintenance

The use of the Frontek part **with its unique honeycomb system** provides numerous advantages.

L'utilisation de la pièce Frontek **avec son système unique de alvéolaires** offre de nombreux avantages.

Reduce el consumo de aire acondicionado y calefacción hasta en un 35 %.

Reduces air conditioning and heating consumption by up to 35%.

Réduire jusqu'à 35 % la consommation de climatisation et de chauffage.

Reduce significativamente el ruido exterior y protege de la radiación solar.

Significantly reduces noise and protects from solar radiation.

Réduit considérablement le bruit extérieur et protège du rayonnement solaire.

Su estructura alveolar minimiza el peso de las piezas

Its honeycomb structure minimizes the weight of the parts

Sa structure en alvéolaires minimise le poids des pièces.

Procesos de construcción eficientes y tiempos más reducidos

Efficient construction processes and shorter construction times

Des processus de construction efficaces et des délais de construction plus courts

Absorción inferior al 0,5% y máxima resistencia a la rotura

Absorption less than 0.5% and maximum breaking strength

Absorption inférieure à 0,5 % et résistance maximale à la rupture

Se minimizan los costes de mantenimiento

Maintenance costs are minimized

Les coûts d'entretien sont réduits au minimum

COLLECTIONS

COLECCIONES | COLLECTIONS

NATURE



SOFT NATURE

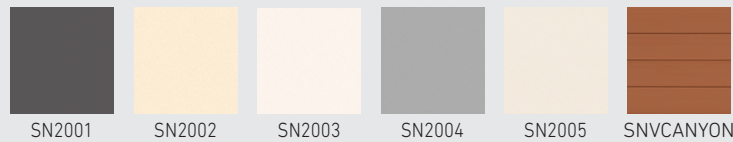

Disponible bajo pedido en todas las medidas y combinable con cualquier modelo excepto texturado.
Available upon request in all sizes and combinable with any model except texture.

TEXTURE



Disponibilidad bajo fabricación hasta ancho 60 cm y combinable con cualquier modelo, color, nature, wood y metálico.

Available under manufacture up to 60 cm wide and combinable with any colour, wood and metallic model.

WOOD

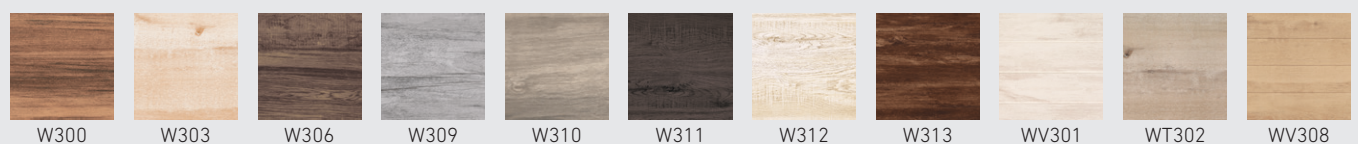

METALLIC



Disponible bajo pedido en todas las medidas y combinable con cualquier volumen o texturado.
Available upon request in all sizes and combinable with any texture or volume.

COLOUR

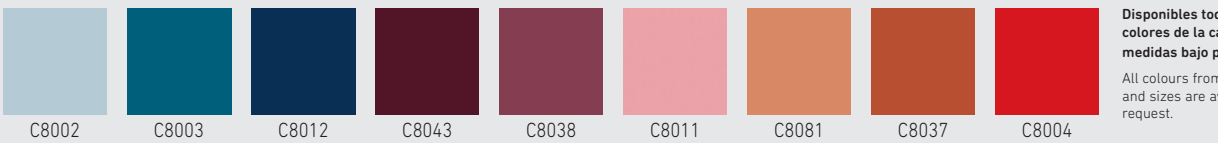
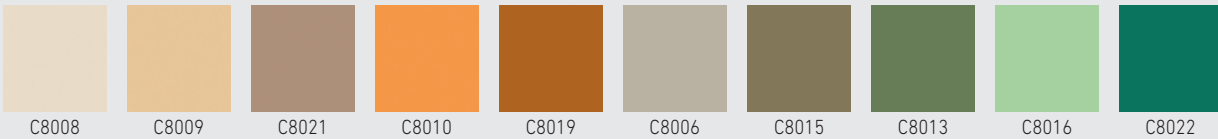

Disponibles todos los colores de la carta RAL y medidas bajo pedido.
All colours from RAL chart and sizes are available on request.

INDIGO

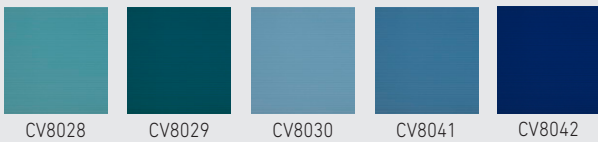

TOUCHE



VOLUME



Fabricación bajo pedido de volumen combinado con cualquier modelo de catálogo, excepto texturado.
Manufacturing on request volume combined with any catalog model, except texture.

XXL

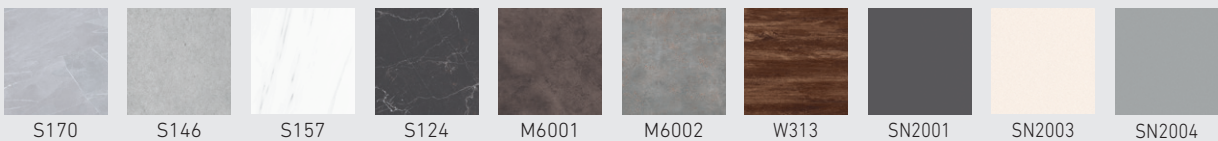

Fabricación bajo pedido de cualquier modelo de catálogo excepto texture.
Manufacturing on request any catalog model except texture.

FORMATS

FORMATOS | FORMATS

Ancho de pieza disponible en medidas 30, 40, 50 y 60 cm, con largo de hasta un máximo de 300 cm. Los tamaños habituales en existencias son 40x80, 40x100 y 60x120 cm en pieza estándar, 80x160 y 100x300 cm en pieza XXL.

Piece width in sizes 30, 40, 50 and 60 cm, up to a maximum length of 300 cm. The standard sizes in stock are 40x80, 40x100 and 60x120 cm. And XXL sizes in stock are 80x160 and 100x300 cm.

Les largeurs des pièces sont disponibles en 30, 40, 50 et 60 cm, avec des longueurs allant jusqu'à 300 cm maximum. Les tailles standard en stock sont 40x80, 40x100 et 60x120 cm. Et les tailles XXL en stock sont 80x160 et 100x300 cm.

PIEZAS alveolares
Honeycomb PIECES
PIÈCES alvéolaires

Pieza ESTÁNDAR | STANDARD piece | Pièce STANDARD



Pieza OMEGA | OMEGA piece | Pièce OMEGA



up to 120 cm | 47,24"

| | |
|---------|--------|
| OMEGA | |
| 30,7 cm | 30 cm |
| 12,09" | 11,81" |

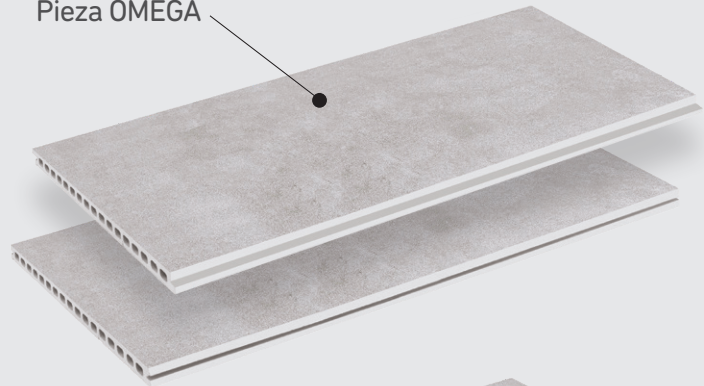
Pieza OMEGA



up to 180 cm | 70,86"

| | | |
|--------|--------|--------|
| 40 cm | 50 cm | 60 cm |
| 15,75" | 19,68" | 23,62" |

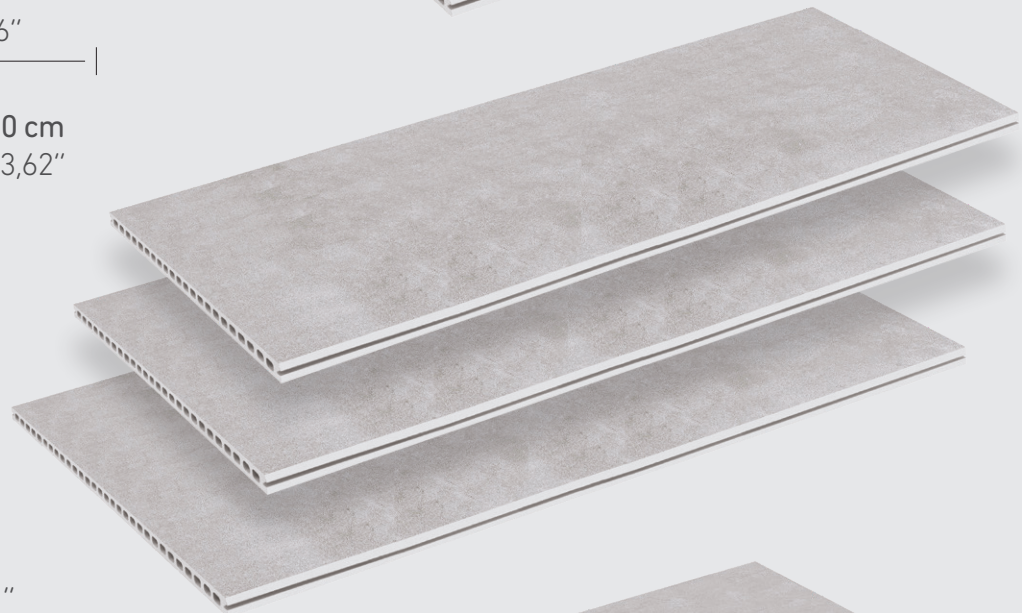

up to 300 cm | 118,11"

| | |
|--------|--------|
| 80 cm | 100 cm |
| 31,49" | 39,37" |

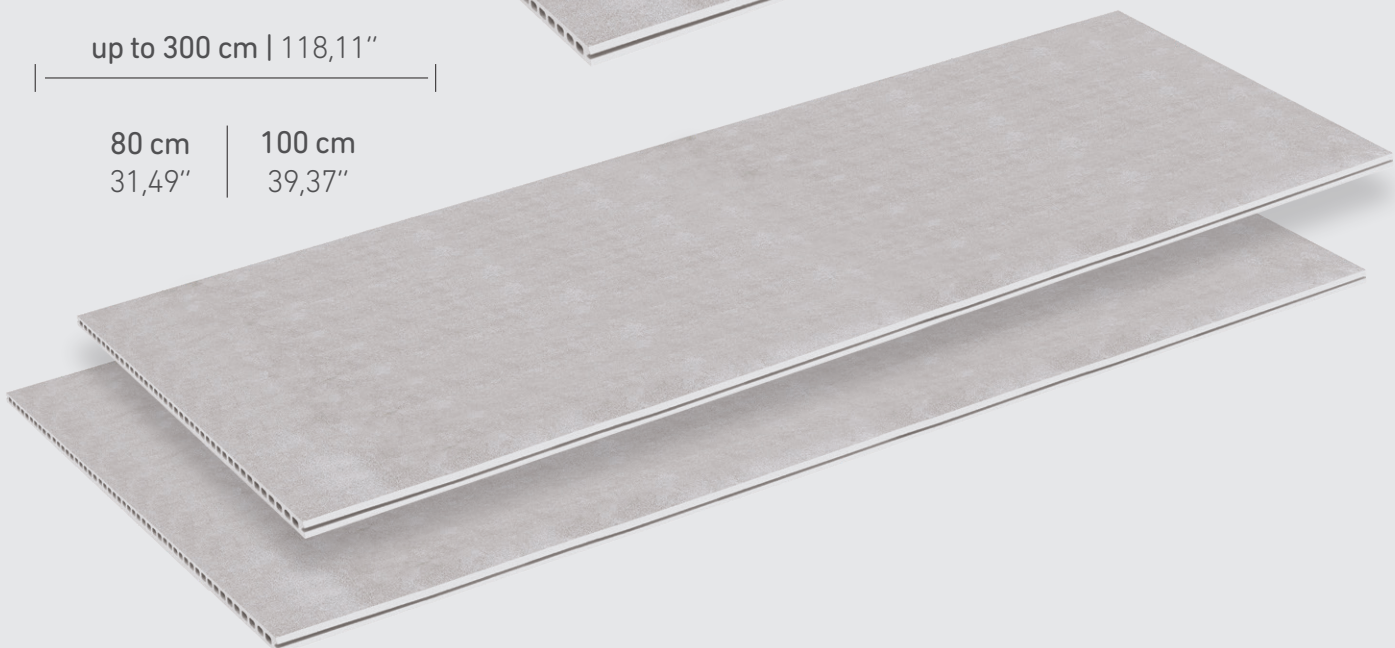

SYSTEMS

SISTEMAS | SYSTÈMES



| PLUS SYSTEM

Ofrece soluciones de fácil instalación y flexibilidad en la resolución de puntos singulares. Su instalación se realiza mediante perfiles verticales y grapas que permiten anclar la pieza horizontal o verticalmente.

It offers easy installation solutions and flexibility in the resolution of singular points. It is installed using vertical profiles and clamps that allow the piece to be anchored horizontally or vertically.

Il offre des solutions d'installation faciles et une flexibilité dans la résolution des points singuliers. Il est installé à l'aide de profils verticaux et de pinces qui permettent d'anclar la pièce horizontalement ou verticalement.

SISTEMA PLUS | PLUS SYSTEM | SYSTÈME PLUS

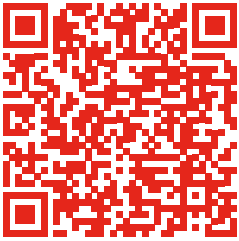

Consulta nuestro **CATÁLOGO TÉCNICO** para más información de productos y sistemas.

See our **TECHNICAL CATALOG** for more information on products and systems.

Consultez notre **CATALOGUE TECHNIQUE** pour plus d'informations sur les produits et les systèmes.



SISTEMA SUPER PLUS | SUPER PLUS SYSTEM | SYSTÈME SUPER PLUS

| SUPER PLUS SYSTEM

Cuenta con perfilera vertical y horizontal para el anclaje de la pieza mediante clips. Permite la combinación de distintos largos de pieza, diseños contrapeados y múltiples aparejos.

It has vertical and horizontal profiles for anchoring the workpiece by means of clips. It allows the combination of different part lengths, counter-top designs, and multiple rigging.

Il dispose de profils verticaux et horizontaux pour l'ancrage de la pièce au moyen de clips. Il permet la combinaison de différentes longueurs de pièces, de conceptions de comptoir et de montages multiples.

SYSTEMS

SISTEMAS | SYSTÈMES

| CLADDING SYSTEM

El aplacado de fachada con pieza cerámica Frontek constituye un cerramiento con mayor protección térmica y acústica frente a cerramientos tradicionales, además de mejorar la durabilidad y el mantenimiento de la fachada.

Este sistema se coloca directamente sobre el cerramiento, mediante grapas de aplacado y adhesivo cementoso.

The facade cladding with Frontek ceramic tile provides greater thermal and acoustic protection than traditional cladding, in addition to improving the durability and maintenance of the facade.

This system is installed directly on the cladding, using cladding clips and cementitious adhesive.

Le revêtement de façade avec les carreaux céramiques Frontek offre une meilleure protection thermique et acoustique que le revêtement traditionnel, tout en améliorant la durabilité et l'entretien de la façade.

Ce système est installé directement sur le bardage, à l'aide de clips de bardage et de ciment-colle.



SISTEMA APLACADO
CLADDING SYSTEM
SYSTÈME FACADE



SISTEMA APLACADO
CLADDING SYSTEM
SYSTÈME FACADE



Consulta nuestro **CATÁLOGO FRONTEK** para más información de productos y colecciones.

See our **FRONTEK CATALOG** for more information on products and collections.

Consultez notre **CATALOGUE FRONTEK** pour plus d'informations sur les produits et les collections.



INSIDE-OUTSIDE SYSTEM

| INSIDE-OUTSIDE SYSTEM

Sistema que tiene como objetivo facilitar la utilización de Frontek en fachadas ventiladas en las que el diseño requiera de volúmenes, tanto por estética como por necesidades técnicas de la fachada. Nace de la evolución de nuestro sistema Super Plus, aportando todas las ventajas del sistema con la flexibilidad compositiva de diseño que permite la colocación de distintas profundidades en la misma fachada.

System that aims to facilitate the use of Frontek in ventilated facades where the design requires volumes, both for aesthetic and technical needs of the facade. It is born from the evolution of our Super Plus system, providing all the advantages of the system with the compositional flexibility of design that allows the placement of different depths in the same facade.

Un système qui vise à faciliter l'utilisation de Frontek dans les façades ventilées où la conception exige des volumes, tant pour des raisons esthétiques que pour les besoins techniques de la façade. Il est né de l'évolution de notre système Super Plus, offrant tous les avantages du système avec la flexibilité de composition du design qui permet de placer différentes profondeurs sur la même façade.



SISTEMA TRASVENTILADO
OMEGA SYSTEM
SYSTÈME OMÉGA

| OMEGA SYSTEM

Ofrece soluciones en puntos singulares y revestimiento de zonas que no requieran de las ventajas de fachada ventilada sin perder su estética.

It offers solutions in singular points and cladding of areas that do not require the advantages of a ventilated facade without losing its aesthetics.

Il offre des solutions dans les points singuliers et le revêtement de zones qui ne nécessitent pas les avantages d'une façade ventilée sans perdre son esthétique.

COLLECTIONS

COLECCIONES | COLLECTIONS

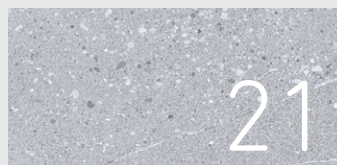

NATURE

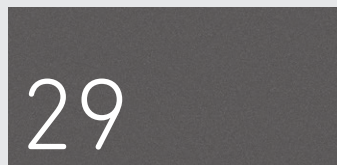

SOFT NATURE



TEXTURE



WOOD



VOLUME

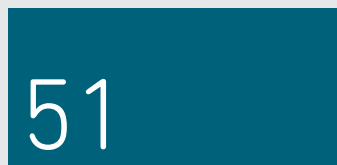

COLOUR

COLLECTIONS

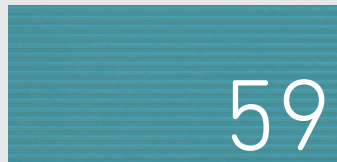

INDIGO



TOUCHE

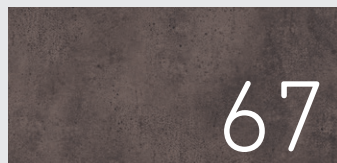

METALLIC

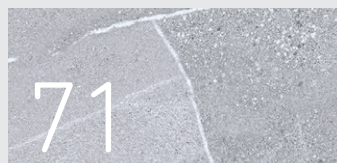

XXL



OMEGA | LATTICES | GRID



REHABILITATION

NATURE



Australia, Melbourne
RMIT
Wellbeing center



S152

Elegancia esencial

Desde la sencillez del porcelánico hasta la elegancia del mármol. Esta línea apuesta por las apariencias naturales con un alto grado de realismo gracias a la última tecnología digital.

Essential elegance

From the simplicity of porcelain to the elegance of marble. This line is committed to natural appearances with a high degree of realism thanks to the latest digital technology.

Élégance essentielle

De la simplicité de la porcelaine à l'élégance du marbre. Cette ligne mise sur des apparences naturelles avec un haut degré de réalisme grâce aux dernières technologies numériques.



S152



Cualquiera de nuestros productos puede ser solicitado y fabricado con la Tecnología Xbacter®.

Any of our products can be requested and manufactured with Xbacter® Technology.

N'importe lequel de nos produits peut être demandé et fabriqué avec la Technologie Xbacter®.

| NATURE



S106

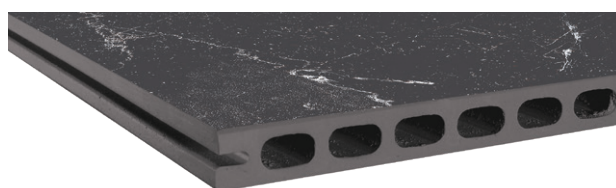
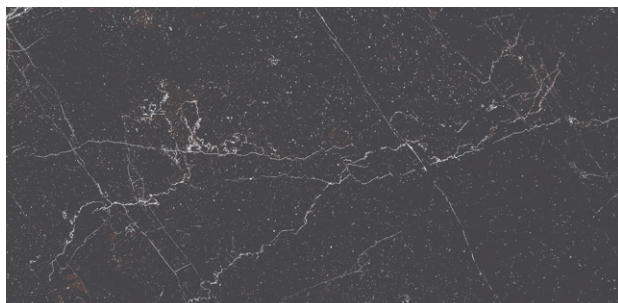

S124

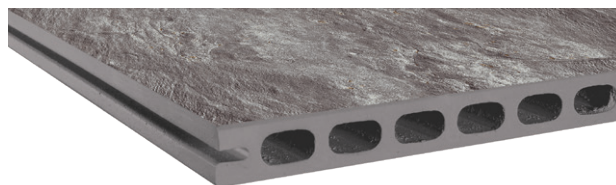

S126



S127

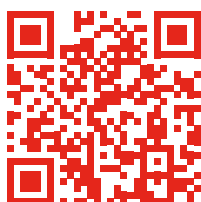

* Disponible bajo pedido en todas las medidas y combinable con cualquier textura o volumen.

* Available upon request in all sizes and combinable with any texture or volume.

* Disponible sur demande dans toutes les tailles et combinable avec n'importe quelle texture ou volume.



S100



S101



S104



S105



S120



S121



S122



S125



S128

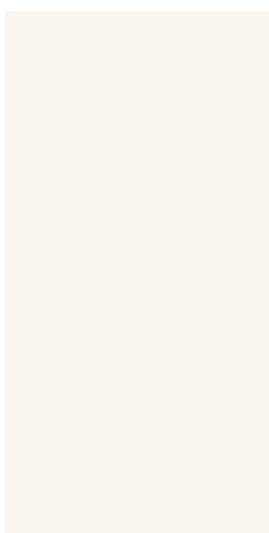

S130



S132



S141

| NATURE

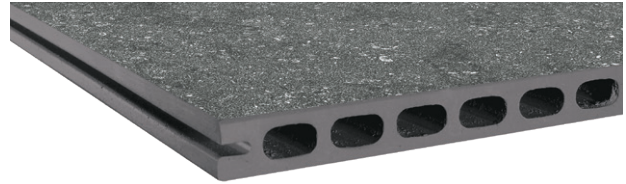
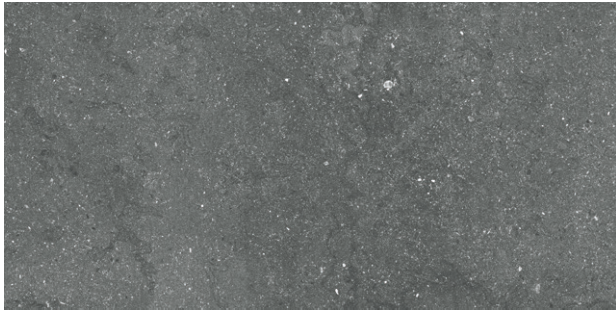

S163



S169



SV153



SV154



* Disponible bajo pedido en todas las medidas y combinable con cualquier textura o volumen.

* Available upon request in all sizes and combinable with any texture or volume.

* Disponible sur demande dans toutes les tailles et combinable avec n'importe quelle texture ou volume.



S142



S151



S152

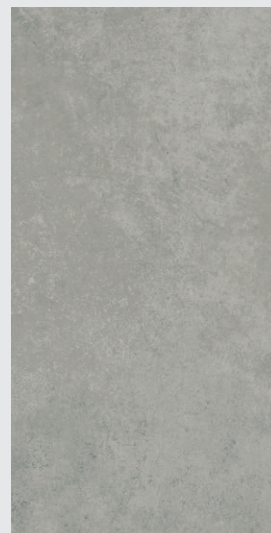

S160

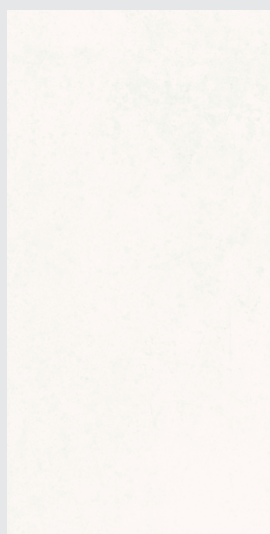

S161



S164



S166

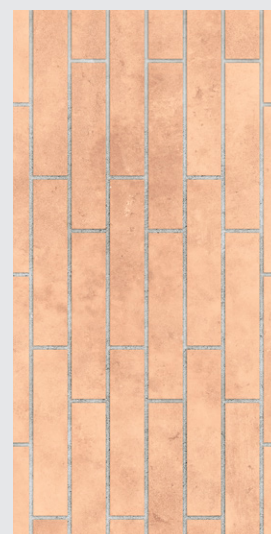

SV112

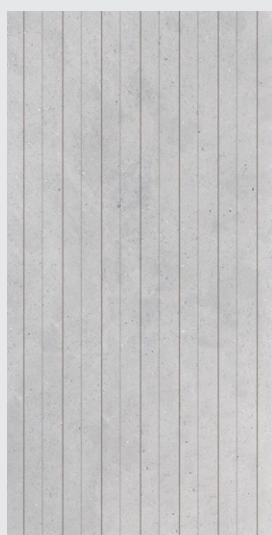

SV141



SV193



URANO

| NATURE



Canada,
Halifax Tower
Hotel



S124



S125



S130

Portugal,
Vila Nova
de Gaia
*Residential
building*



S106



M6001



UAE, Dubai
Vezul
*Residential
building*



S130

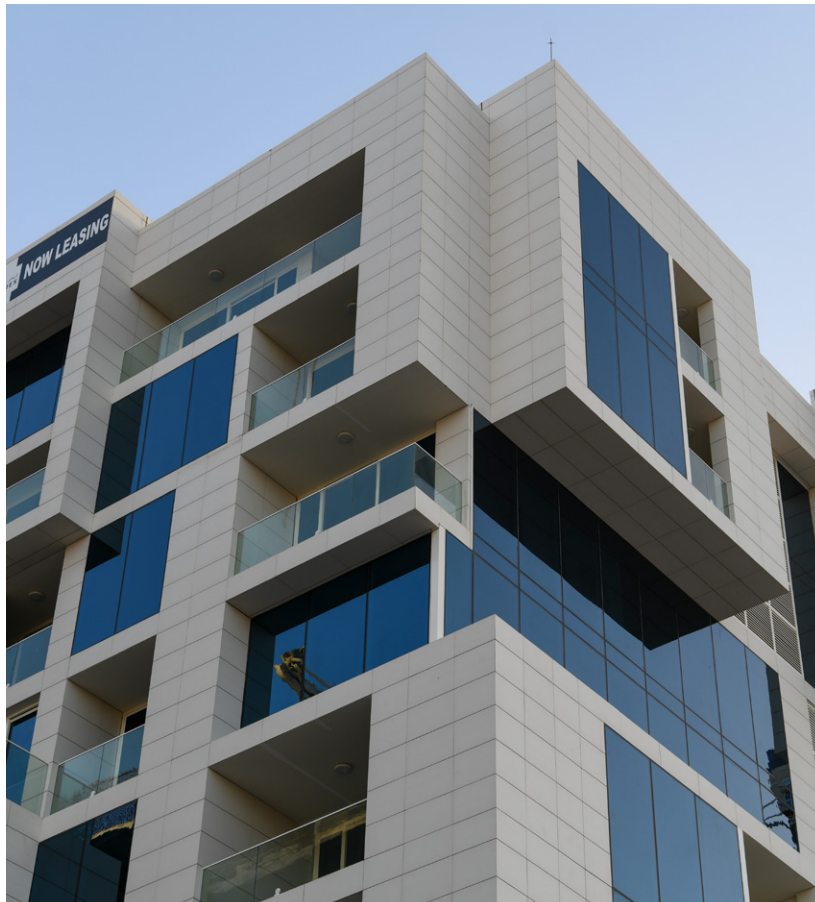

SOFT NATURE



Asia, South Korea
Daegu
Office Building



SN2004

Atractivo funcional

Tonos naturales y ligera textura para una línea de modelos que se ajustan a diseños modernos con una gama de colores que se adapta a proyectos en variedad de estilos.

Functional appeal

Natural tones and light texture for a range of models to suit modern designs with a range of colours to suit projects of many styles.

Attractivité fonctionnelle

Des tons naturels et une texture légère pour une gamme de modèles adaptés aux conceptions modernes avec une gamme de couleurs pour s'adapter aux projets de nombreux styles.

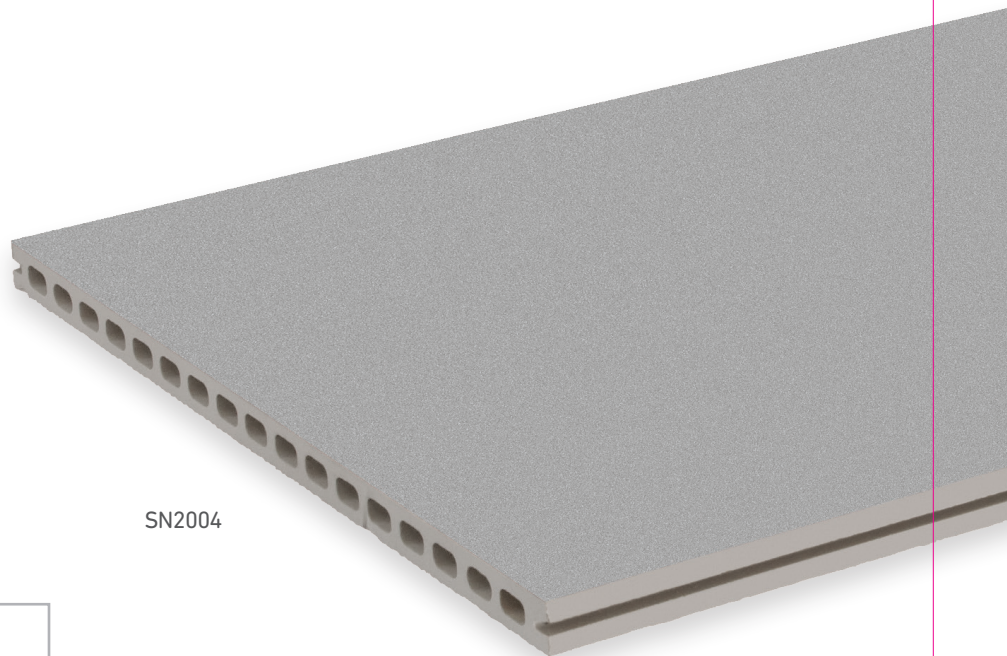

SN2004



Cualquiera de nuestros productos puede ser solicitado y fabricado con la Tecnología Xbacter®.

Any of our products can be requested and manufactured with Xbacter® Technology.

N'importe lequel de nos produits peut être demandé et fabriqué avec la Technologie Xbacter®.

| SOFT NATURE

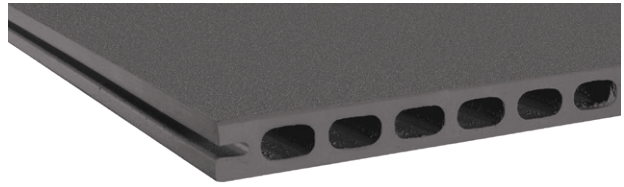
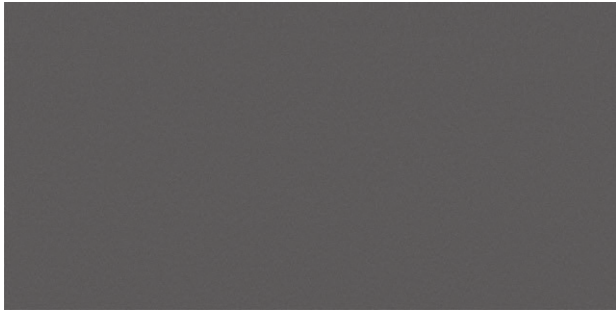

SN2001

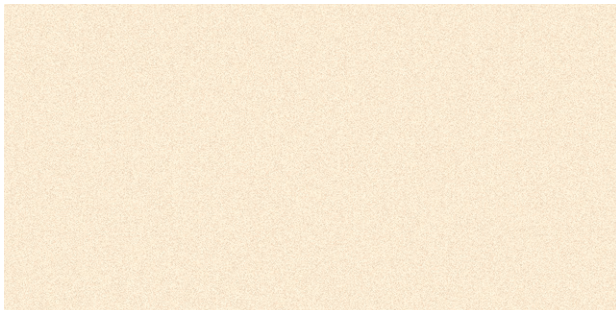

SN2002

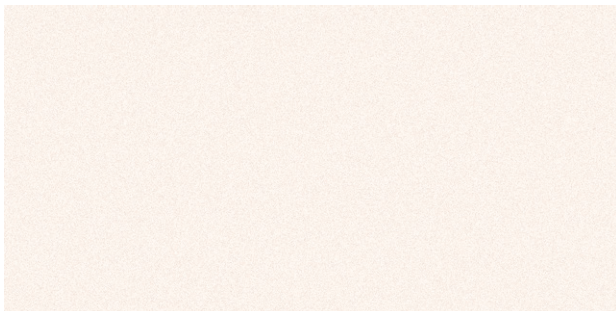

SN2003



* Disponible bajo pedido en todas las medidas y combinable con cualquier modelo excepto texture.

* Available upon request in all sizes and combinable with any model except texture.

* Disponible sur demande dans toutes les tailles et combinable avec tous les modèles sauf la texture.

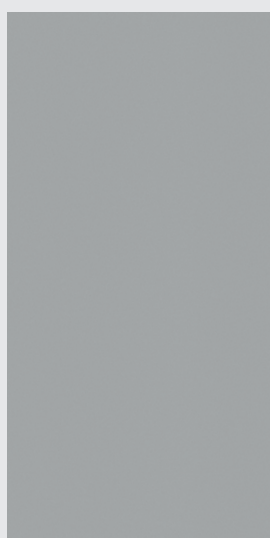

SN2004

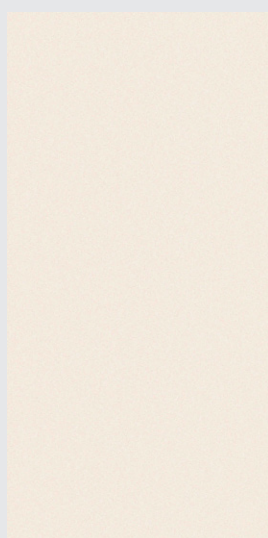

SN2005

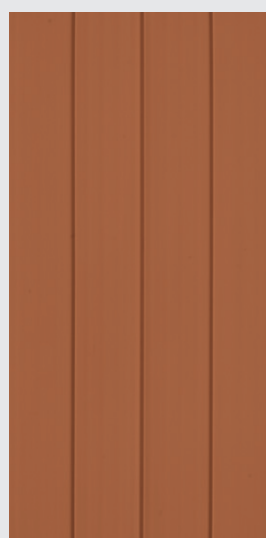

SNVCANYON

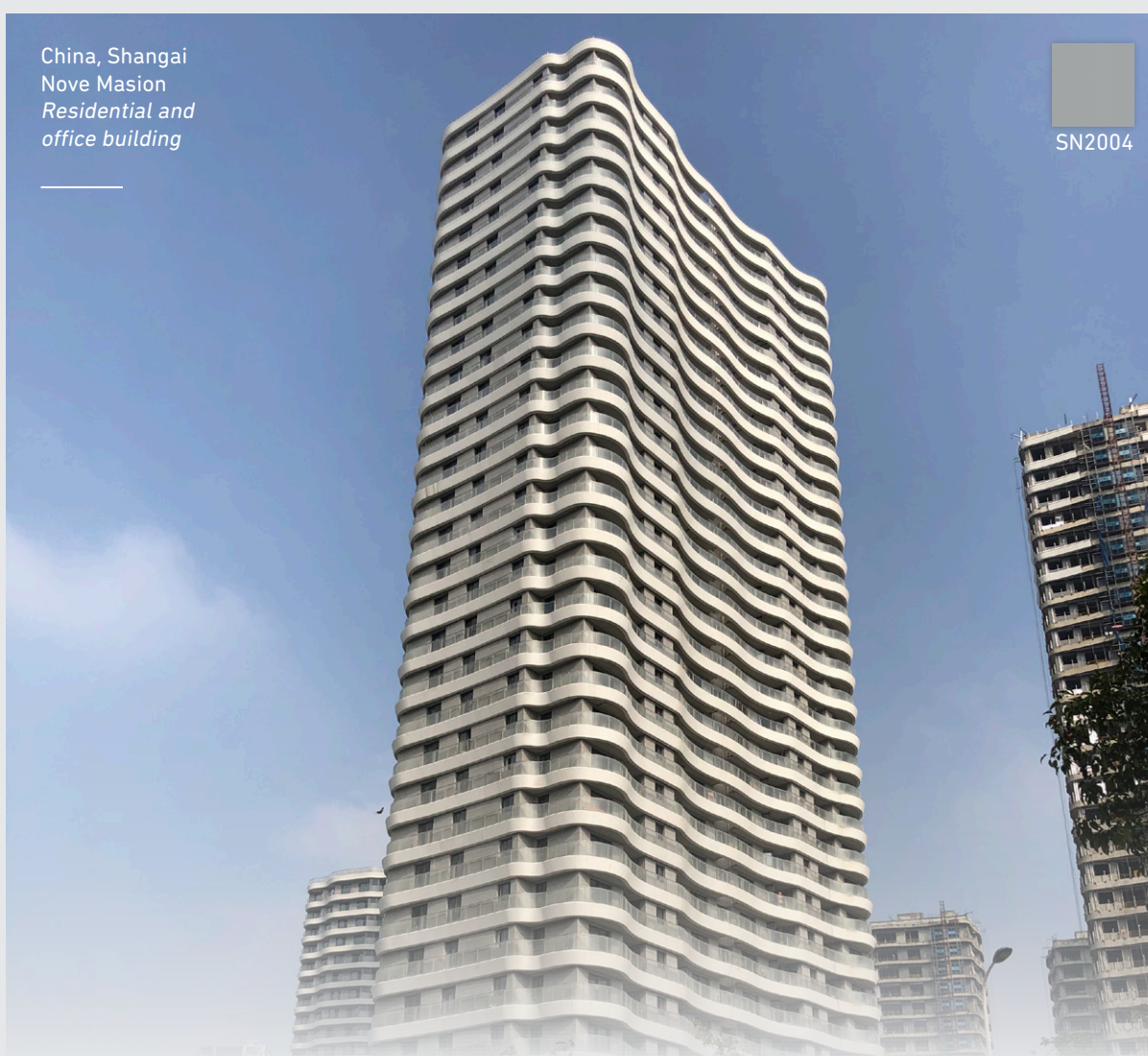

China, Shangai
Nove Masion
Residential and
office building

SN2004

TEXTURE



UAE, Abu Dhabi
*Residential
Building*

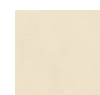

ICEBERG

Texturas naturales

Con un verdadero estilo atemporal, esta gama destaca por sus originales piezas de masa completa en lo que a color se refiere. Colores naturales, regulares, pero a su vez, con notable destonificación en cada trama. De texturas más prominentes. Medidas disponibles hasta un ancho máx. de 60cms.

Natural textures

With a truly timeless style, this range stands out for its original full mass pieces in terms of color. Natural, regular colors, but at the same time, with remarkable shading in each weft. More prominent textures. Sizes available up to a maximum width of 60cms.

Textures naturelles

D'un style véritablement intemporel, cette gamme se distingue par l'originalité de ses pièces de masse en termes de couleur. Des couleurs naturelles et régulières, mais en même temps, avec des nuances notables dans chaque trame. Avec des textures plus saillantes. Tailles disponibles jusqu'à une largeur maximale de 60 cm.



Cualquiera de nuestros productos puede ser solicitado y fabricado con la Tecnología Xbacter®.

Any of our products can be requested and manufactured with Xbacter® Technology.

N'importe lequel de nos produits peut être demandé et fabriqué avec la Technologie Xbacter®.

| TEXTURE

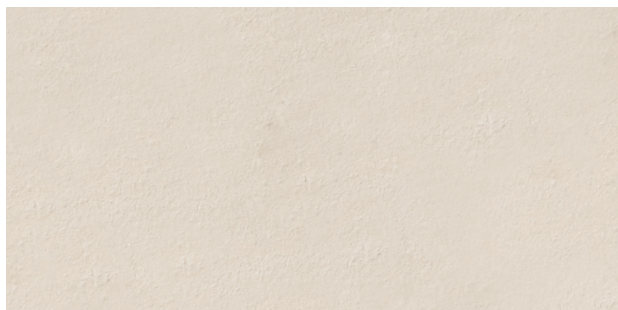

ST5006

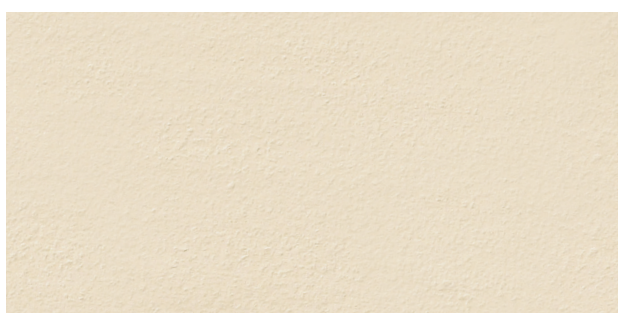

ICEBERG

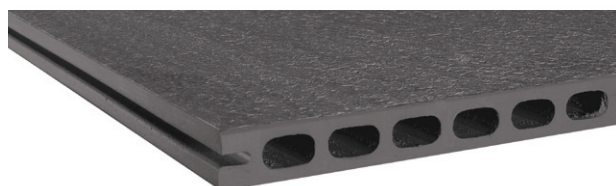

AZABACHE

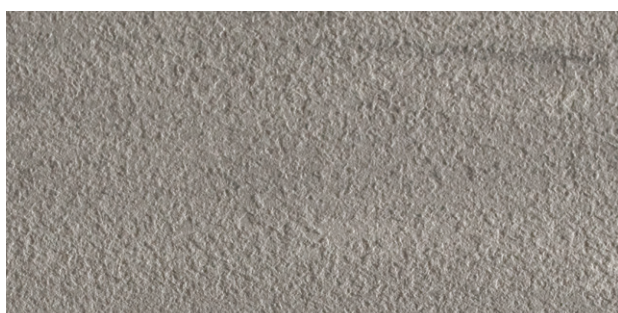

JUPITER

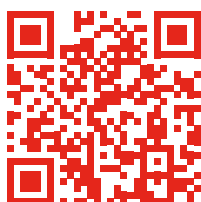

* Disponibilidad bajo fabricación hasta ancho 60cm y combinable con cualquier modelo colour, nature, wood y metallic.

* Available under manufacture up to 60cm wide and combinable with any colour, nature, wood and metallic model.

* Disponible sous fabrication jusqu'à 60cm de large et combinable avec tout modèle couleur, nature, bois et métallique.



ST108

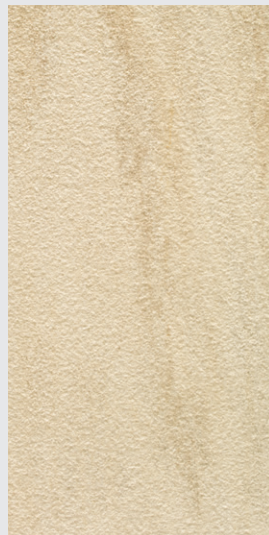

ST110



ST123



ST183



URBAN



CANYON



CERES

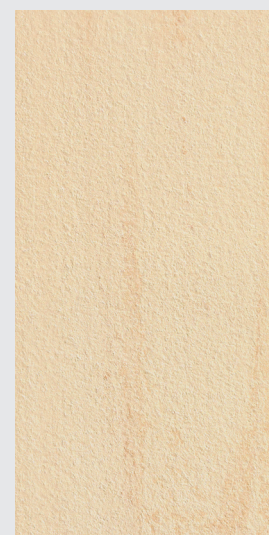

SONORA



Spain, Valencia
Office
building

URBAN

| TEXTURE



India, New Delhi
Gys Towers
Office building



ICEBERG



AZABACHE

Spain, Girona
Detached house



ICEBERG



Spain, Madrid
Residential building



ST5006



JUPITER



WOOD



Spain, Madrid
*Residential
building*



W311



W310



W306

Belleza natural

No podía faltar uno de los acabados más elegantes como es la madera. Las ventajas del porcelánico tecnológico por extrusión se unen a la belleza de un material noble para ofrecer una moderna y elegante opción para el recubrimiento de fachadas.

The beauty of nature

One of the most elegant finishes, wood, could not be left out. The advantages of technological extruded porcelain tiles combine with the beauty of a noble material to offer a modern and elegant option for façade cladding.

La beauté de la nature

L'une des finitions les plus élégantes, le bois, ne pouvait être laissée de côté. Les avantages des carreaux technologiques en porcelaine extrudée s'allient à la beauté d'un matériau noble pour offrir une option moderne et élégante pour le revêtement des façades.



W310



Cualquiera de nuestros productos puede ser solicitado y fabricado con la Tecnología Xbacter®.

Any of our products can be requested and manufactured with Xbacter® Technology.

N'importe lequel de nos produits peut être demandé et fabriqué avec la Technologie Xbacter®.

| WOOD



W300



W303



W306

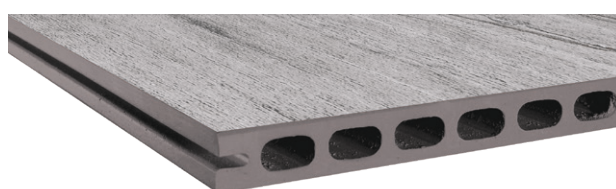

W309

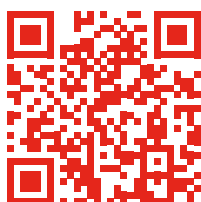

* Disponible bajo pedido en todas las medidas y combinable con cualquier textura o volumen.

* Available upon request in all sizes and combinable with any texture or volume.

* Disponible sur demande dans toutes les tailles et combinable avec n'importe quelle texture ou volume.

Spain, Barcelona
Residential
building



W300



W310



W311



W312



W313



WT302



WV301

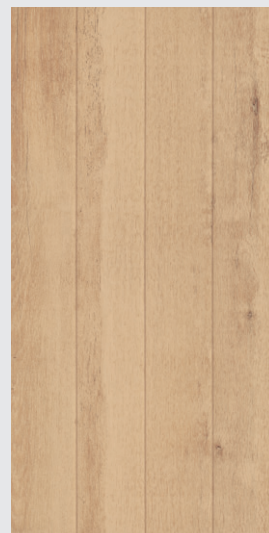

WV308

| WOOD



Spain, Madrid
Residential building



W311



W310



W306

Spain, Madrid
Residential building



W311



W310



W306



Spain, Madrid
Residential building



W300



VOLUME



Spain, Madrid
*Detached
houses*



SV154

Carácter sensorial

Gama de piezas con efecto de volumen en su superficie con diferentes acabados. Desde ranurado sencillo hasta un gran acanalado. Combinable con todos los modelos y tonalidades, excepto los texturados. Medidas disponibles hasta un ancho de 60cm.

Sensorial character

A range of pieces with a volume effect on their surface with different finishes. From simple grooves to large grooves. Combinable with all models and shades, excepting texture. Sizes available up to a width of 60cm.

Caractère sensoriel

Une gamme de pièces avec un effet de volume sur leur surface avec différentes finitions. Des simples rainures aux grandes rainures. Combinable avec tous les modèles et toutes les teintes, sauf ceux qui sont texturés. Tailles disponibles jusqu'à une largeur de 60 cm.



Cualquiera de nuestros productos puede ser solicitado y fabricado con la Tecnología Xbacter®.

Any of our products can be requested and manufactured with Xbacter® Technology.

N'importe lequel de nos produits peut être demandé et fabriqué avec la Technologie Xbacter®.

| VOLUME

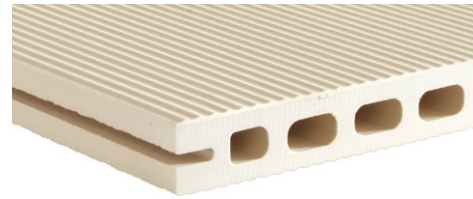

V1001

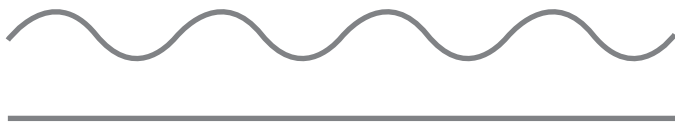

V1002



V1003



V1004

| Fabricación a demanda
On-demand manufacturing | Fabrication à la demande

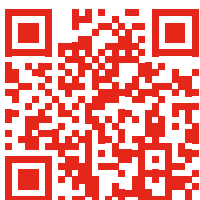

* Fabricación bajo pedido de volumen combinado con cualquier modelo de catálogo, excepto texture.

* Manufacturing on request volume combined with any catalog model, except texture.

* Manufacturiers sur demande du volume combiné avec n'importe quel modèle de catalogue, sauf texture.

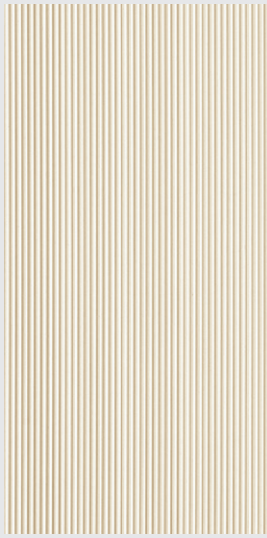

V1001

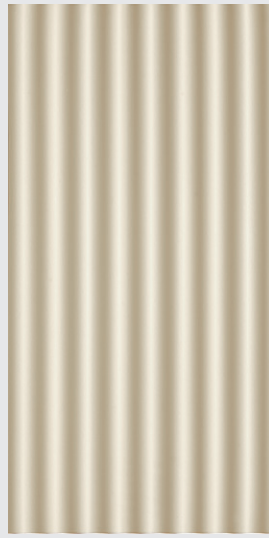

V1002

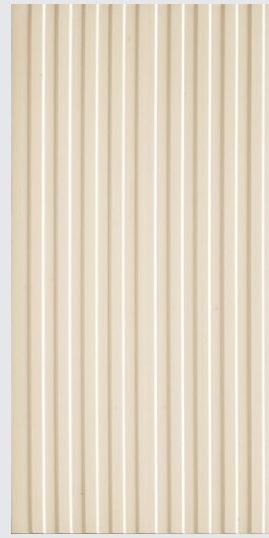

V1003

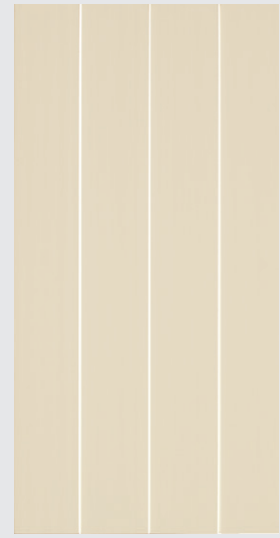

V1004



V1005



V1006



V1007

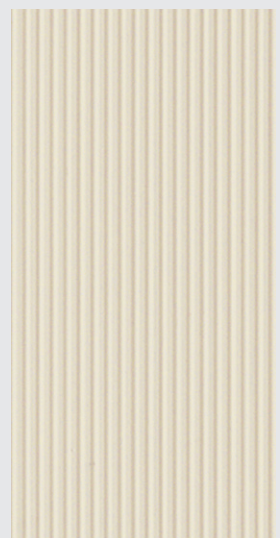

V1008



Spain, Madrid
*Detached
houses*

SV154

| VOLUME



Spain, Madrid
Residential building



AZABACHE



V1003

Russia,
Novgorod
Nizhny
School



SNVCANYON



AZABACHE



UAE, Abu Dhabi
Residential building



V1003



AZABACHE

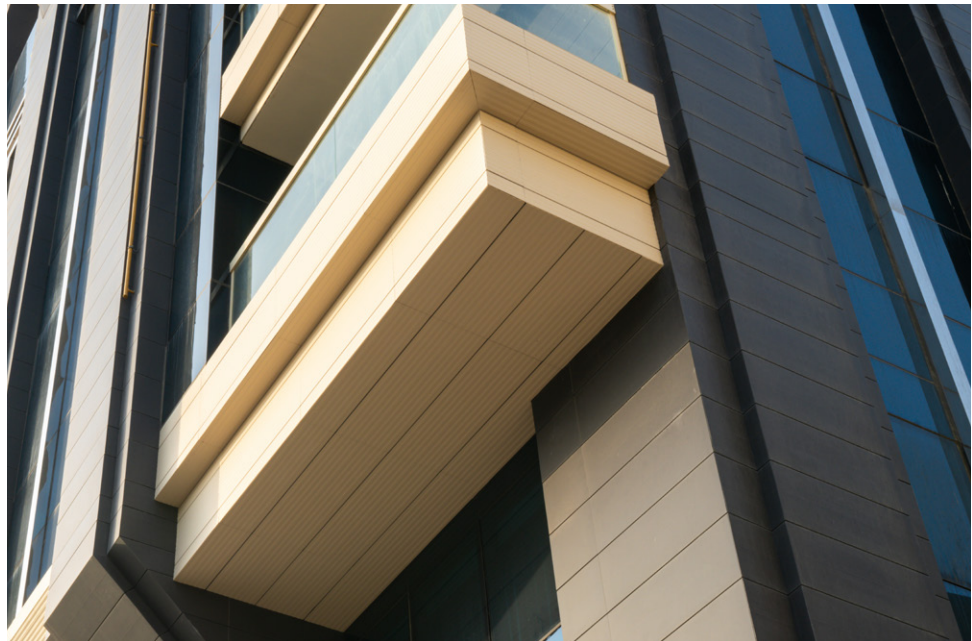

Spain, Madrid
Residential building



V1003
AZABACHE

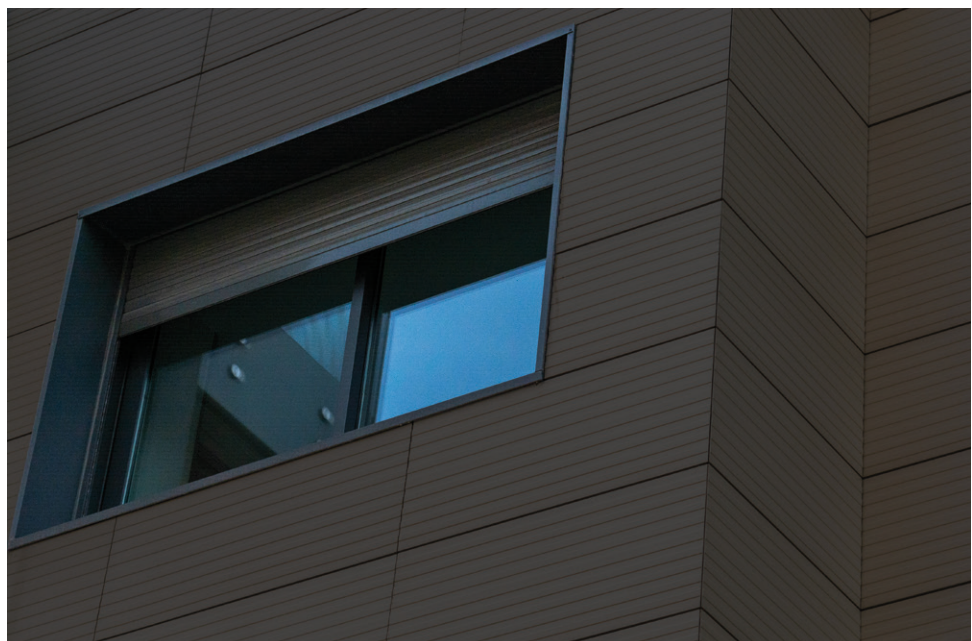

COLOUR



Spain, Bilbao
Residential
building



C8003



C8002

Tonalidades ral

La carta RAL disponible en la gama más extensa de Frontek. Infinidad de posibilidades con opción de desarrollar cualquier tonalidad de la carta bajo demanda, con un listado de colores ya desarrollados para fabricación inmediata.

Ral shades

The RAL chart available in Frontek's most extensive range. Infinite possibilities with the option to develop any shade of the chart on demand, with a list of colours already developed for immediate production.

Couleurs ral

La charte RAL disponible dans la gamme la plus étendue de Frontek. Des possibilités infinies avec la possibilité de développer n'importe quelle teinte de la charte sur demande, avec une liste de couleurs déjà développées pour une production immédiate.

C8012 |

C8002 |

C8017 |

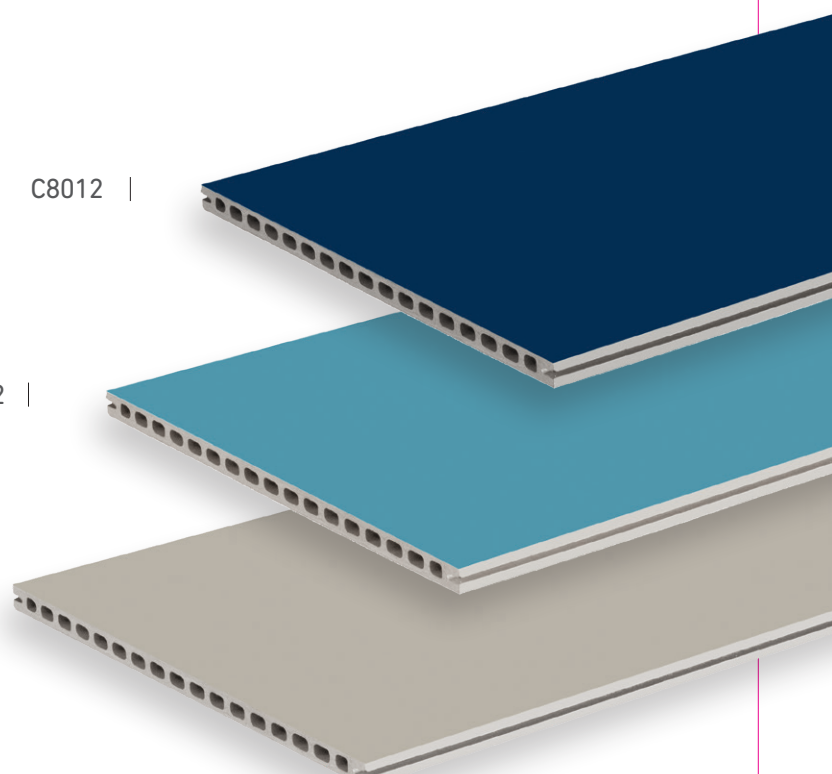

Cualquiera de nuestros productos puede ser solicitado y fabricado con la Tecnología Xbacter®.

Any of our products can be requested and manufactured with Xbacter® Technology.

N'importe lequel de nos produits peut être demandé et fabriqué avec la Technologie Xbacter®.

| COLOUR

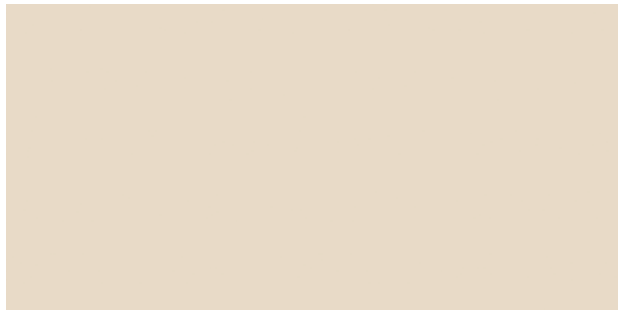

C8008



C8002

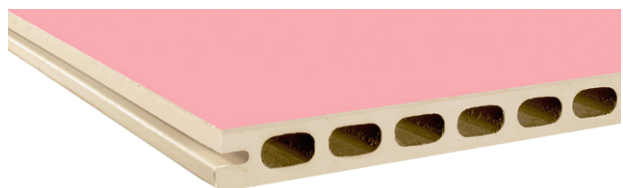

C8011



C8013

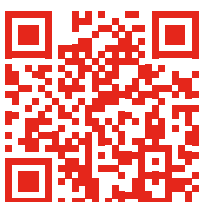

* Disponibles todos los colores de la carta RAL y medidas bajo pedido. Frontek dispone de tonalidades desarrolladas y listas para fabricación.

* All colours from the RAL chart and sizes are available on request. Frontek offers many shades already developed and ready for production.

* Toutes les couleurs RAL et les dimensions sont disponibles sur demande. Frontek a développé des nuances et est prêt pour la production.

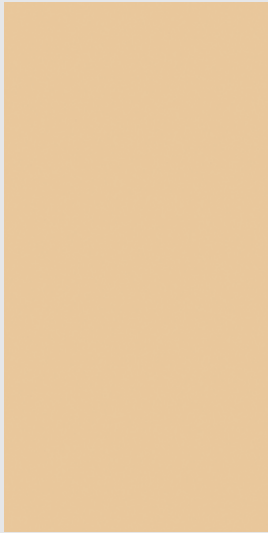

C8009

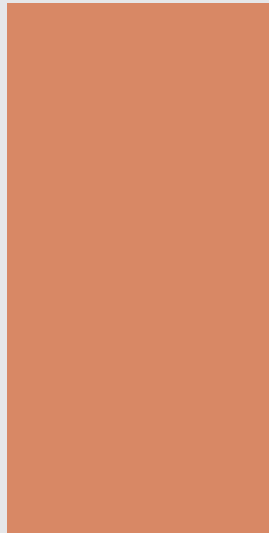

C8081



C8037



C8043



C8006



C8021



C8003



C8012



Spain, Madrid
Infant
school



C8001

| COLOUR



C8022



C8010



C8015



C8021

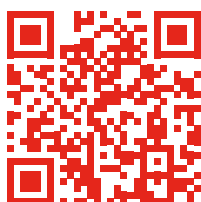

* Disponibles todos los colores de la carta RAL y medidas bajo pedido. Frontek dispone de tonalidades desarrolladas y listas para fabricación.

* All colours from the RAL chart and sizes are available on request. Frontek offers many shades already developed and ready for production.

* Toutes les couleurs RAL et les dimensions sont disponibles sur demande. Frontek a développé des nuances et est prêt pour la production.



C8019



C8007



C8016

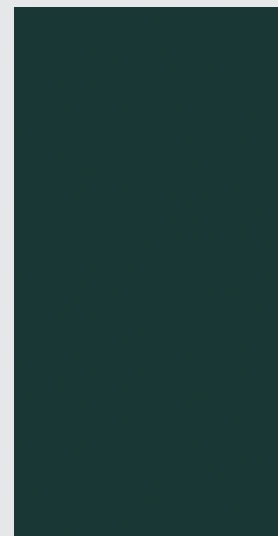

C8014



C8038



C8120



C8004

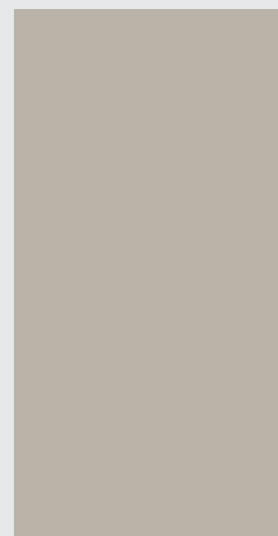

C8017

| COLOUR



Canada,
West Coast
Medical Center



C8002



SN2004



SN2001



Spain, Bilbao
Residential building



C8015



UAE,
Abu Dhabi
Red Crescent Office building



C8004



S130



INDIGO



Spain,
Islas Baleares
Detached house

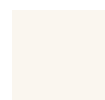

S130



CV8030

Actual y singular

Desde las profundidades del mar, nace la colección Indigo tomando como inspiración las ondas del oleaje para crear una pieza dinámica con volumen propio.

Una variada paleta de azules que crearán ambientes sorprendentes con una textura que realza el atractivo de la pieza. Sin duda creará espectaculares mosaicos por su versatilidad de gama.

Current and singular

From the depths of the sea, the Indigo collection is born, taking as inspiration the waves to create a dynamic piece with its own volume.

A varied palette of blues that will create surprising environments with a texture that enhances the attractiveness of the piece. It will undoubtedly create spectacular mosaics due to its versatility of range.

Actuel et unique

Des profondeurs de la mer est née la collection Indigo, qui s'inspire des vagues du surf pour créer une pièce dynamique avec son propre volume.

Une palette variée de bleus qui crée des atmosphères surprenantes avec une texture qui renforce l'attrait de la pièce. Il créera sans aucun doute des mosaïques spectaculaires grâce à la polyvalence de sa gamme.

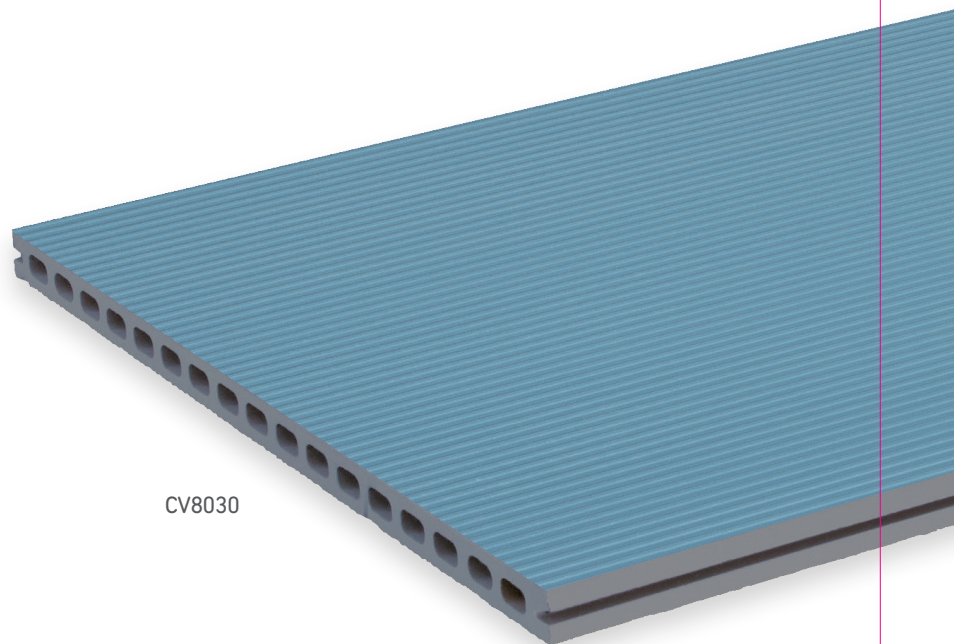

CV8030



Cualquiera de nuestros productos puede ser solicitado y fabricado con la Tecnología Xbacter®.

Any of our products can be requested and manufactured with Xbacter® Technology.

N'importe lequel de nos produits peut être demandé et fabriqué avec la Technologie Xbacter®.

INDIGO

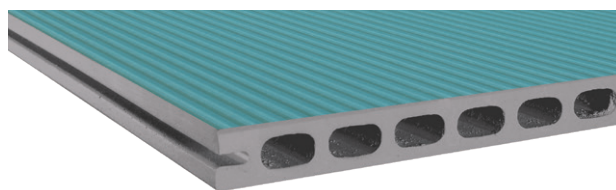
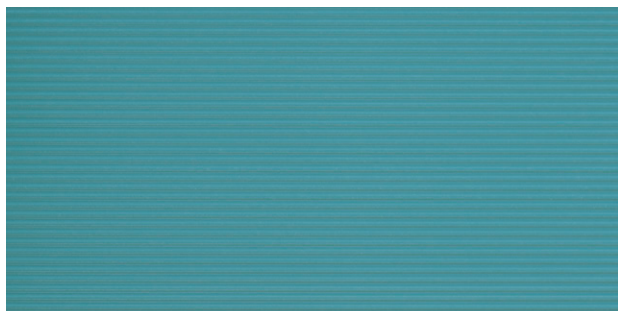

CV8028

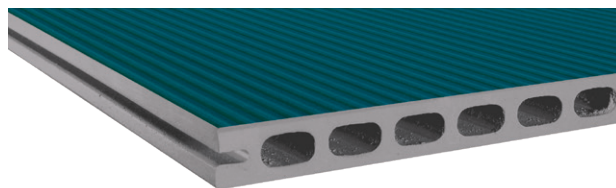
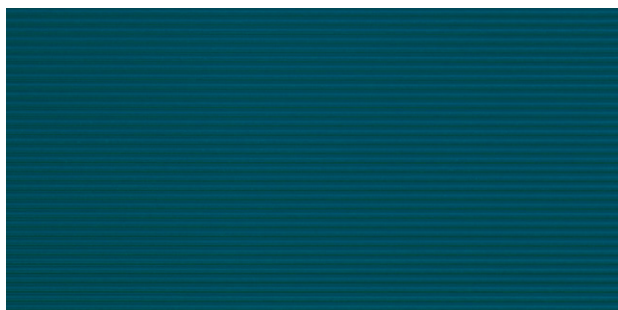

CV8029

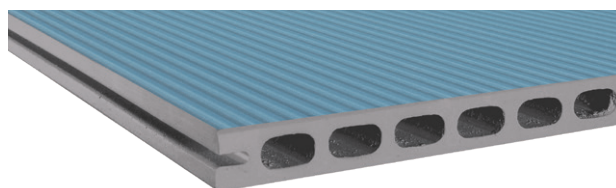
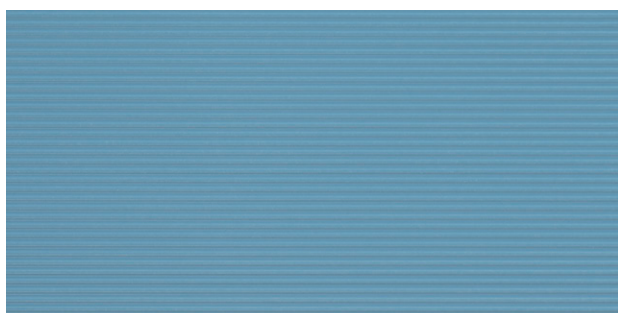

CV8030

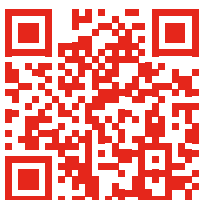
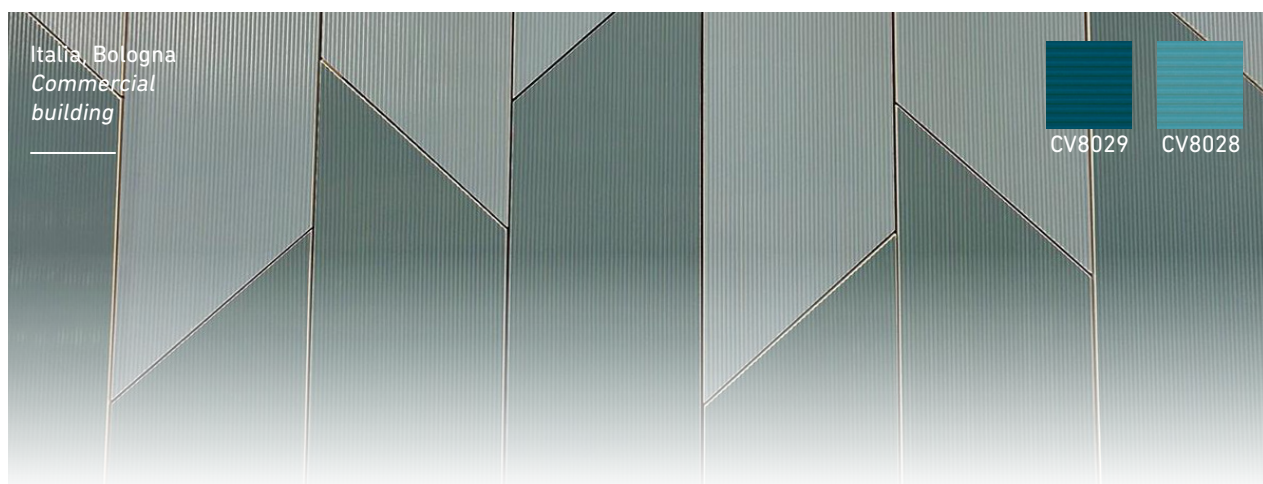

* Fabricación bajo pedido de volumen combinado con cualquier modelo de catálogo, excepto texture.

* Manufacturing on request volume combined with any catalog model, except texture.

* Manufacturiers sur demande du volume combiné avec n'importe quel modèle de catalogue, sauf texture.

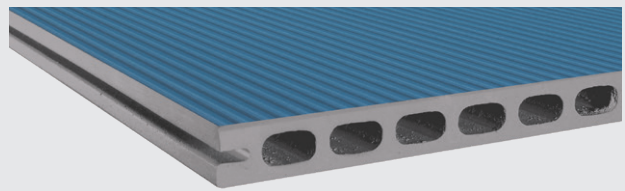
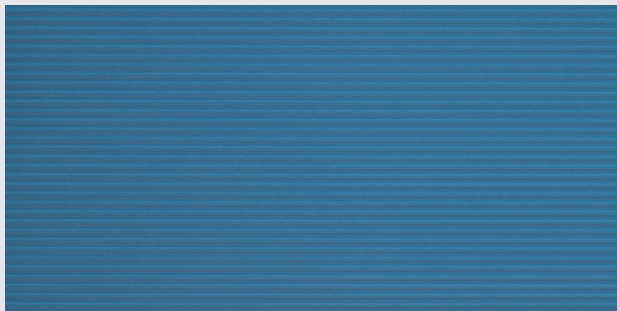

CV8041

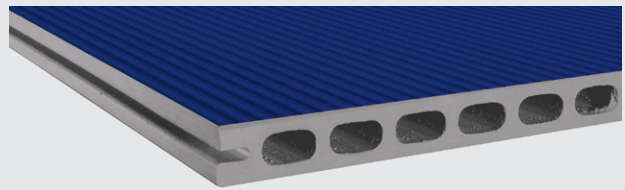
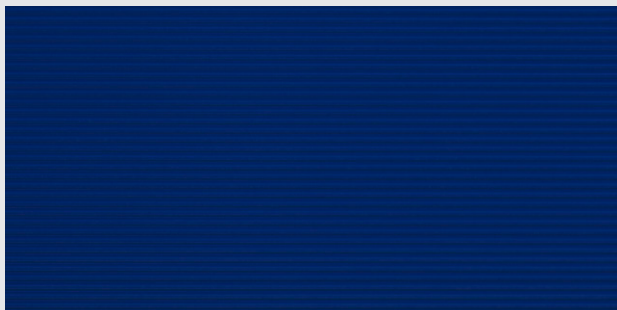

CV8042



Spain,
Islas Baleares
Detached house

CV8041

TOUCHE



Spain,
Islas Baleares
Detached house

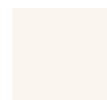

S130



SN184

Elegancia sin límites

Con un elegante y moderno relieve que invita al tacto, es una elección ideal para aquellos que buscan calidad, belleza y funcionalidad en cada detalle de su proyecto arquitectónico. Sus colores neutros y cálidos complementan cualquier proyecto tanto de interior como de exterior, con una inusitada elegancia atemporal.

Unlimited elegance

With an elegant and modern relief that invites touch, it is an ideal choice for those who seek quality, beauty and functionality in every detail of their architectural project. Its neutral and warm colours complement any indoor or outdoor project with an unusual timeless elegance.

Une élégance sans limite

Avec un relief élégant et moderne qui invite au toucher, c'est un choix idéal pour ceux qui recherchent la qualité, la beauté et la fonctionnalité dans chaque détail de leur projet architectural. Ses couleurs neutres et chaudes complètent tout projet d'intérieur ou d'extérieur avec une élégance intemporelle inhabituelle.

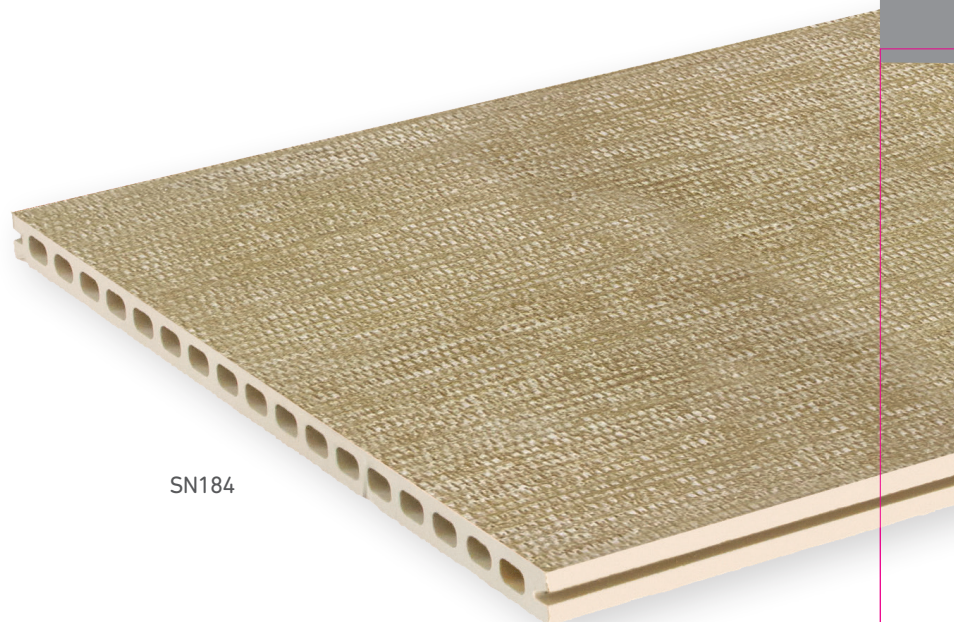

SN184



Cualquiera de nuestros productos puede ser solicitado y fabricado con la Tecnología Xbacter®.

Any of our products can be requested and manufactured with Xbacter® Technology.

N'importe lequel de nos produits peut être demandé et fabriqué avec la Technologie Xbacter®.

| TOUCHE



SN181

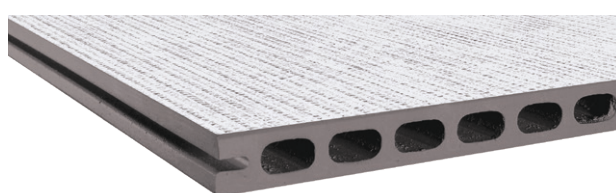

SN182



SN184

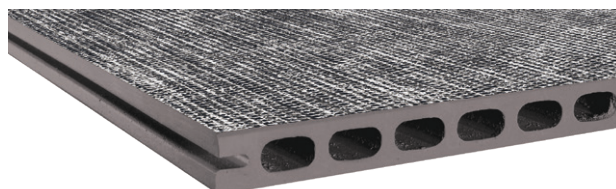
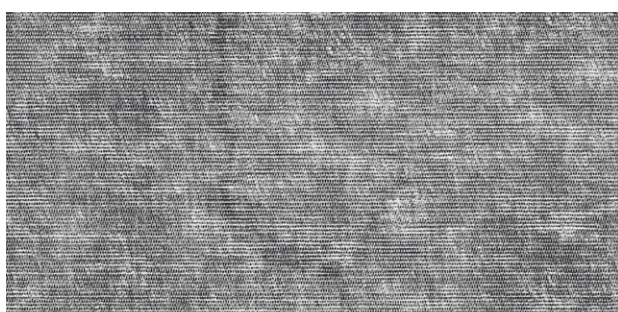

SN185

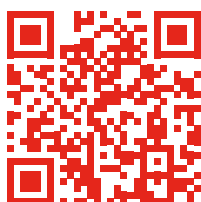

* Fabricación bajo pedido de volumen combinado con cualquier modelo de catálogo, excepto texture.

* Manufacturing on request volume combined with any catalog model, except texture.

* Manufacturiers sur demande du volume combiné avec n'importe quel modèle de catalogue, sauf texture.



Spain,
Islas Baleares
Detached house



SN184



S130

METALLIC



Spain, Toledo
Commercial building



JUPITER

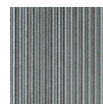

MT7002

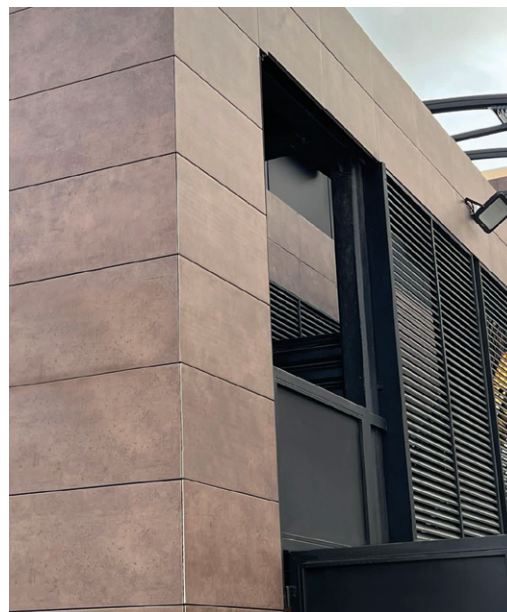

Israel,
Commercial building



M6001

Versátil y actual

Acabados actuales e innovadores con la gama de metálicos Frontek. Ideales para fachadas modernas y diseños vanguardistas con unas piezas con la belleza del metal y todas las cualidades técnicas del porcelánico extruido.

Versatile and up-to-date

Modern and innovative finishes with the Frontek metallic range. Ideal for modern façades and avant-garde designs in pieces with the beauty of metal and all the technical qualities of extruded porcelain tiles.

Versatile et contemporain

Des finitions modernes et innovantes avec la gamme Frontek metallic. Idéal pour les façades modernes et les conceptions avant-gardistes de pièces ayant la beauté du métal et toutes les qualités techniques des carreaux en porcelaine extrudée.

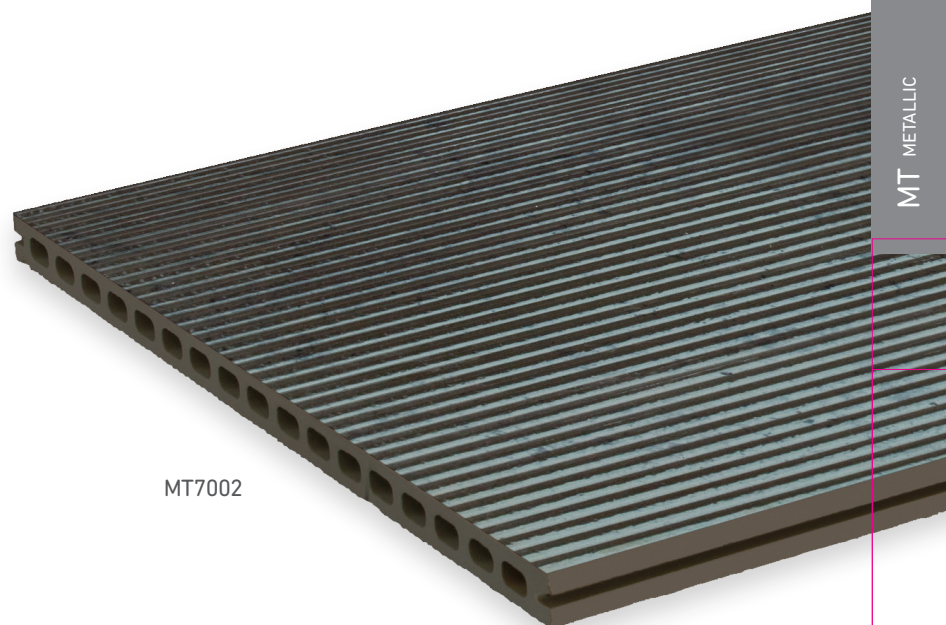

MT METALLIC



Cualquiera de nuestros productos puede ser solicitado y fabricado con la Tecnología Xbacter®.

Any of our products can be requested and manufactured with Xbacter® Technology.

N'importe lequel de nos produits peut être demandé et fabriqué avec la Technologie Xbacter®.

| METALLIC

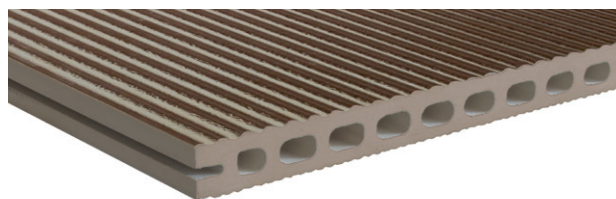
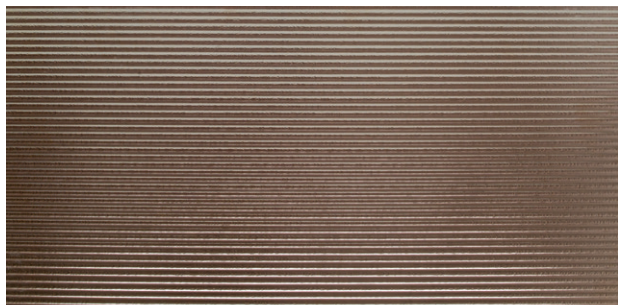

MT7001

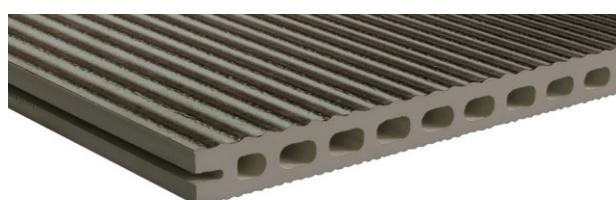
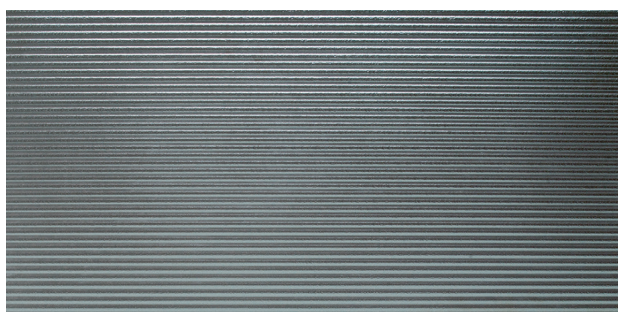

MT7002

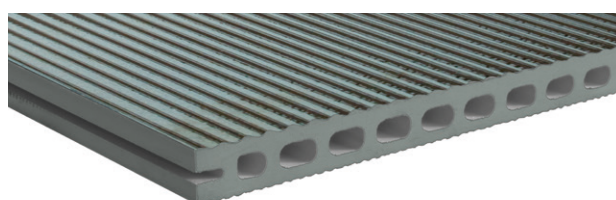
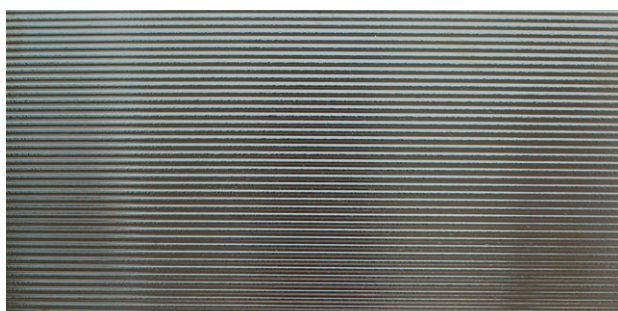

M7003

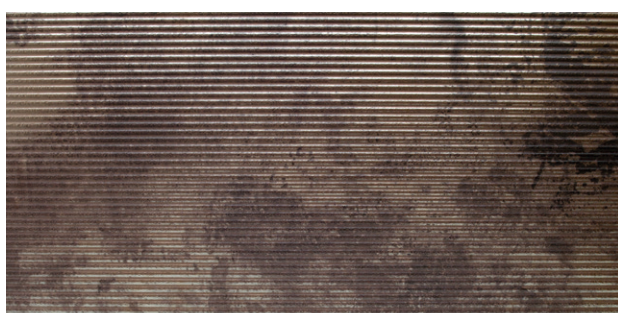

M7004

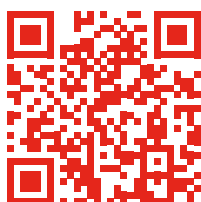

* Disponible bajo pedido en todas las medidas y combinable con cualquier textura o volumen.

* Available upon request in all sizes and combinable with any texture or volume.

* Disponible sur demande dans toutes les tailles et combinable avec n'importe quelle texture ou volume.

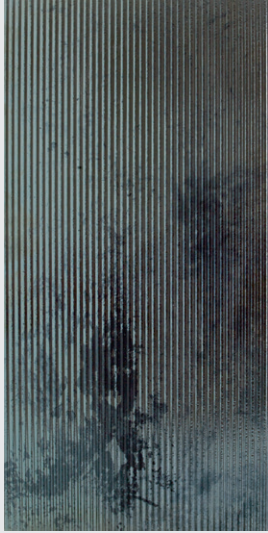

MT7005



M6001



M6002



MV6001



Spain, Pamplona
Residential building



M6002



Africa, Gabon
Office building



M6001



M6002

XXL



Australia, Sidney
*Macquarie
University*



S109 XXL

Gran Formato

Gama XXL de piezas de gran formato de hasta 100x300 cm, que permiten fachadas amplias e innovadoras. El manejable tamaño de 80x160 cm precisa de un sistema de anclaje similar al de pieza estándar. Esta gama permite la colocación en horizontal y vertical, ampliando sus opciones estéticas y funcionales.

Big Format

XXL range of large-format pieces up to 100x300 cm, allowing for open and innovative façades. The manageable size of 80x160 cm requires an anchoring system similar to the standard piece. This range allows the installation horizontally and vertically, expanding its aesthetic and functional options.

Large Format

Gamme XXL de pièces de grand format jusqu'à 100x300 cm, permettant de réaliser des façades de grande taille et innovantes. La taille maniable de 80x160 cm nécessite un système d'ancrage similaire à celui de la pièce standard. Cette gamme peut être installée horizontalement et verticalement, ce qui élargit ses options esthétiques et fonctionnelles.

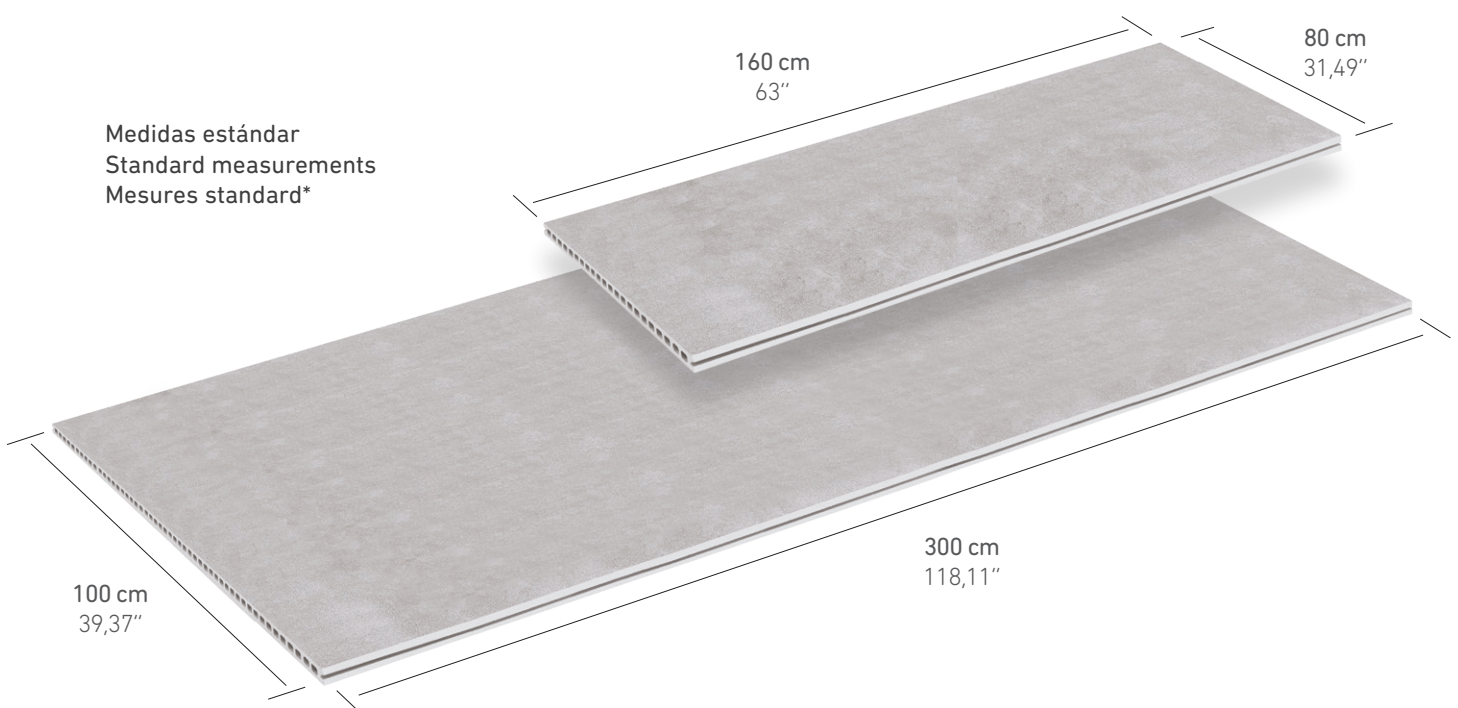

* Disponibilidad bajo fabricación en otros largos, bajo pedido mínimo.
* Availability under manufacture in other lengths, under minimum order.
* Disponibilité en fabrication dans d'autres longueurs, sous minimum de commande.

| XXL

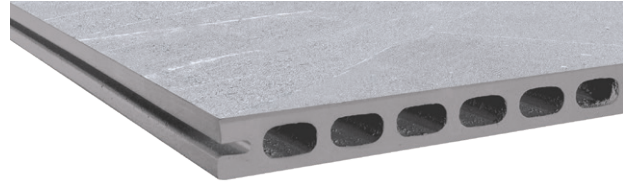
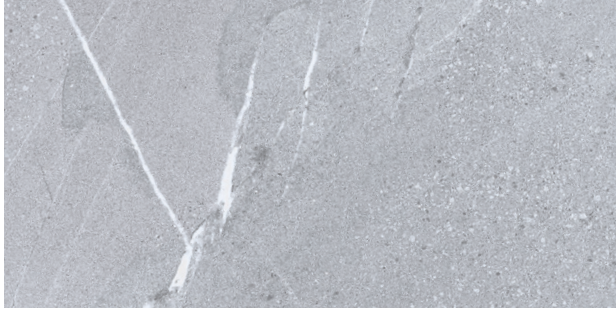

S170

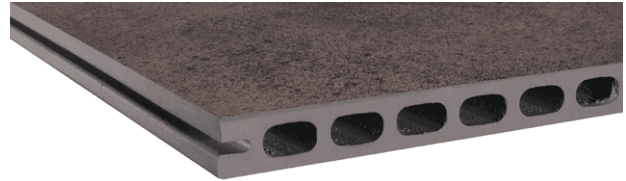

M6001

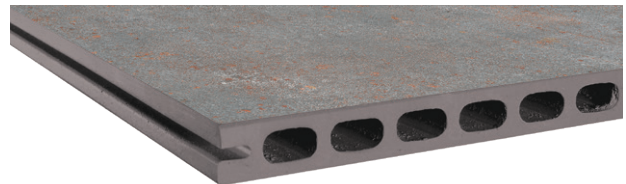
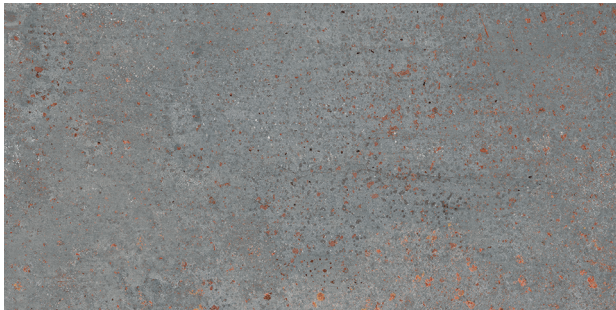

M6002



S157



* Disponible bajo pedido en todas las medidas y combinable con cualquier textura o volumen.

* Available upon request in all sizes and combinable with any texture or volume.

* Disponible sur demande dans toutes les tailles et combinable avec n'importe quelle texture ou volume.



S146

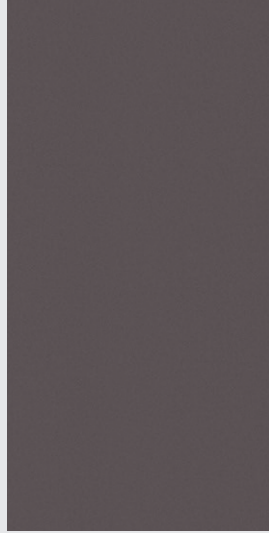

SN2001

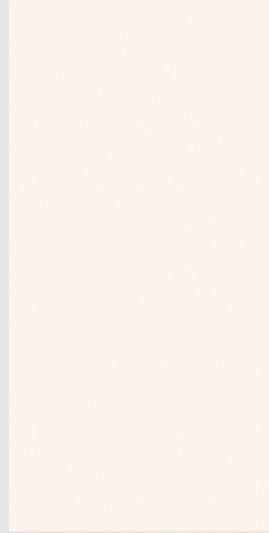

SN2003

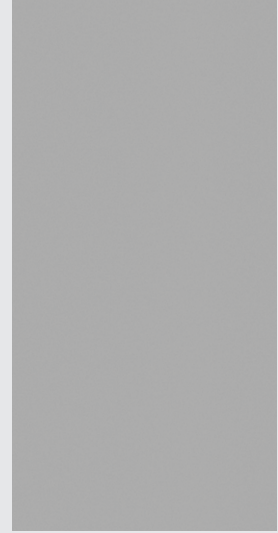

SN2004

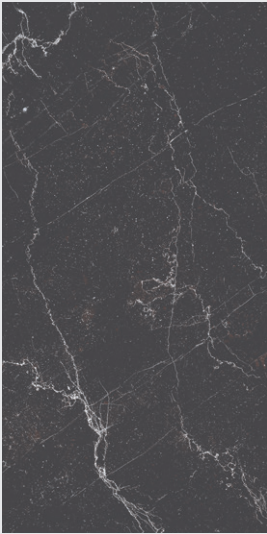

S124



W313

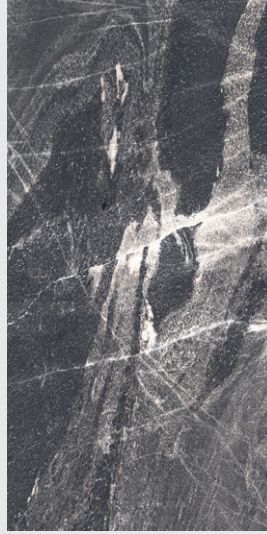

SN3001



SNV191



SV141



SV193

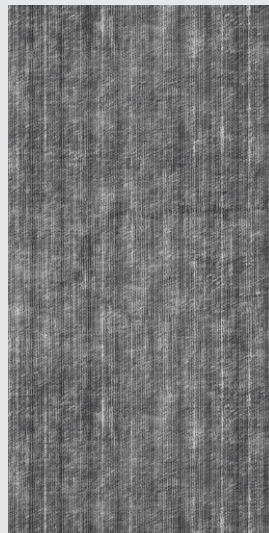

SNV185



MV6001

| XXL



China, Shanghai
Office building



SN2003

Australia, Sidney
Maquarie
University



S109 XXL



XXL

OMEGA | LATTICES | GRID

OMEGA | LAMAS | REJILLAS | OMEGA | TREILLIS | GRID



Spain, Madrid
*Office
building*

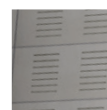

ST5001

OMEGA | LATTICES | GRID |

Soluciones efectivas

Las piezas especiales Frontek ofrecen múltiples soluciones. La pieza Omega reduce la junta horizontal, solapando unas piezas con otras con el fin de encubrir el sistema. ALFA Lamas, para celosías en forma de lama veneciana. La rejilla Frontek permite la circulación del aire sin alterar la estética de la fachada.

Effective solutions

Special parts offer a variety of solutions. The Omega part reduces the joint between parts by overlapping the anchoring system. ALFA Lamas, for Venetian louvres. The Frontek louvre allows air circulation with the same aesthetics as the façade.

Des solutions efficaces

Les pièces spéciales Frontek offrent de multiples solutions. La pièce Omega réduit le joint horizontal, en superposant une pièce à une autre afin de couvrir le système. ALFA Lamas, pour les persiennes vénitiennes. La grille Frontek permet la circulation de l'air sans altérer l'esthétique de la façade.

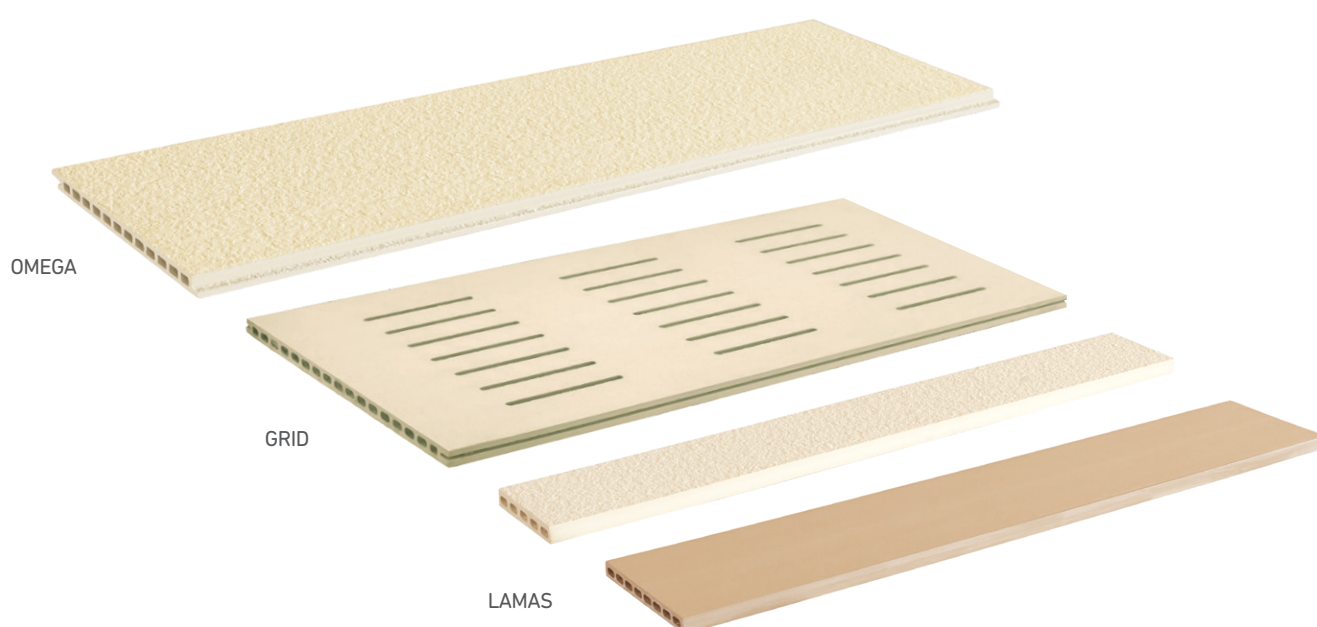

| OMEGA | LATTICES | GRID

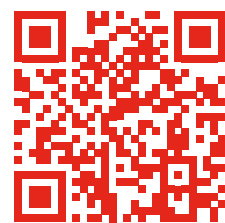

Fabricación en ancho 30,7 y
largo hasta 120cm

Manufacture in width 30,7 and
length up to 120cm

Fabrication en largeur 30,7 et
en longueur jusqu'à 120cm



OMEGA



OMEGA

Omega / Omega

La pieza Omega se caracteriza por su perfil horizontal especialmente diseñado para que en su colocación la junta quede oculta en su lado largo. Con posibilidad de colocación en horizontal y vertical. Se pueden fabricar en cualquier modelo de catálogo excepto gama volumen.

The Omega piece is characterised by its specially designed horizontal profile so that the joint is concealed on the long side when installed. Can be installed horizontally and vertically. They can be manufactured in any catalogue model except the volume range.

La pièce Omega se caractérise par son profil horizontal spécialement conçu, de sorte que le joint est dissimulé sur le côté long lors de la pose. Peut être installé horizontalement et verticalement. Ils peuvent être fabriqués dans tous les modèles du catalogue, à l'exception de la gamme de volume.

| OMEGA | LATTICES | GRID

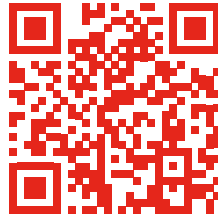

* Disponible bajo pedido en toda la gama Frontek, excepto Volumen.

* Available upon request in frontek's full range, except volume.

* Disponible sur demande sur l'ensemble de la gamme Frontek, sauf le volume.

LATTICES

lamas / croisillons

ALFA Lamas es una exclusiva pieza para la realización de lamas, compatible con cualquiera de los sistemas de fachada ventilada Frontek y con sistemas clásicos de recubrimiento de fachadas.

Cuidado diseño en forma de lama veneciana que se ofrece en varias medidas y en todos los acabados Frontek. Se puede instalar con sistemas fijos y móviles, cubriendo las necesidades de todo proyecto.

Las Lamas Frontek actúan desviando la luz solar, impidiendo así que los rayos entren de forma directa hacia el interior, mejorando la eficiencia energética y manteniendo la ventilación natural del edificio.



LATTICES

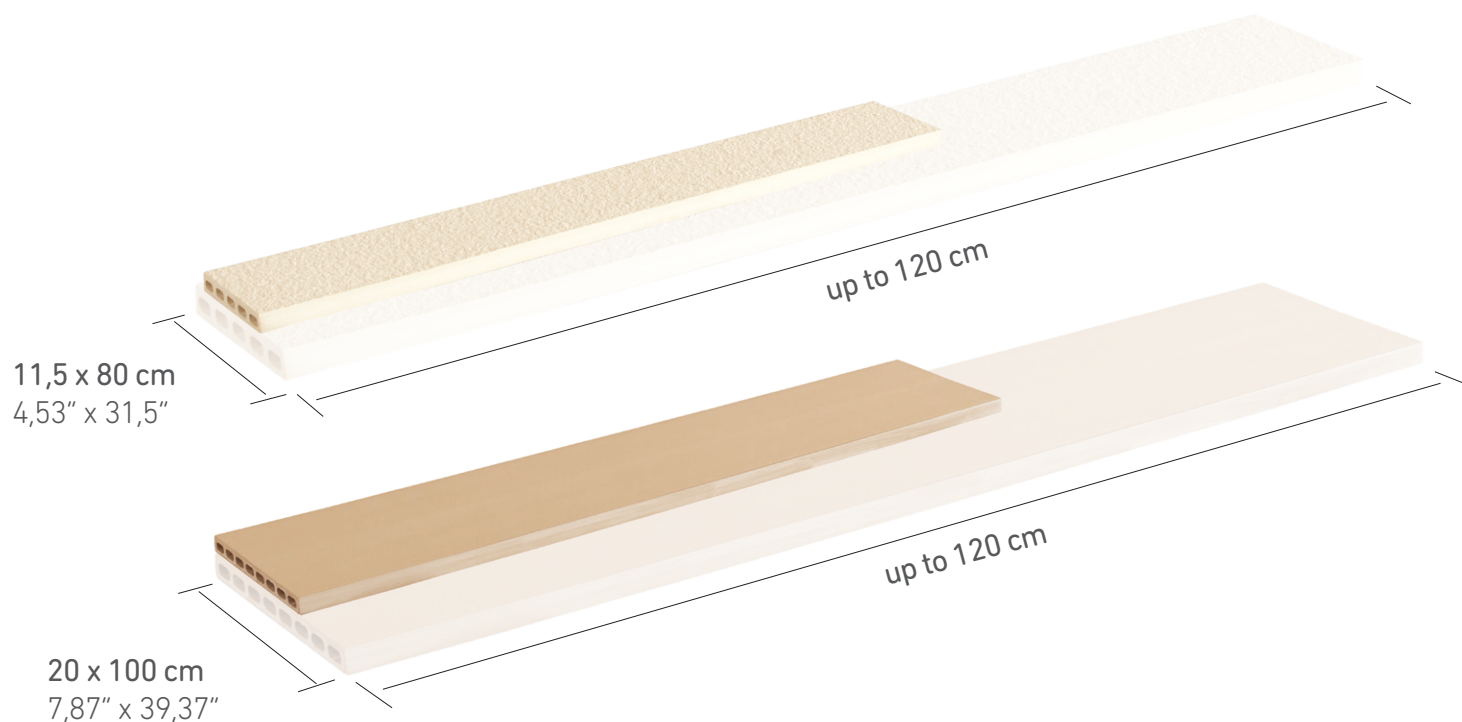

Ofor the creation of lattices, compatible with any of the Frontek ventilated façade systems and with classic facade cladding systems.

Carefully designed in the shape of a Venetian slat, it is available in various sizes and in all Frontek finishes. It can be installed with fixed and mobile systems, covering the needs of any project.

Frontek slats act by deflecting sunlight, thus preventing direct sunlight from entering the interior, improving energy efficiency and maintaining the natural ventilation of the building.

ALFA Lamas est une pièce exclusive pour la création de treillis, compatible avec tous les systèmes de façade ventilée Frontek et avec les systèmes classiques de revêtement de façade.

Soigneusement conçu en forme de latte vénitienne, il est disponible en différentes tailles et dans toutes les finitions Frontek. Il peut être installé avec des systèmes fixes et mobiles, couvrant ainsi les besoins de tout projet.

Les lamelles Frontek agissent en déviant la lumière du soleil, empêchant ainsi la lumière directe du soleil de pénétrer à l'intérieur, améliorant l'efficacité énergétique et maintenant la ventilation naturelle du bâtiment.

| OMEGA | LATTICES | GRID

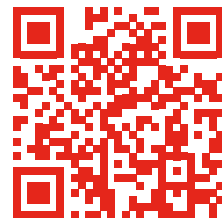

* Consultar otras medidas y diseños. Disponible en toda la gama Frontek.

* Check out other measures and designs. Available in frontek's full range.

* Consultez d'autres mesures et designs. Disponible dans toute la gamme Frontek.

GRID

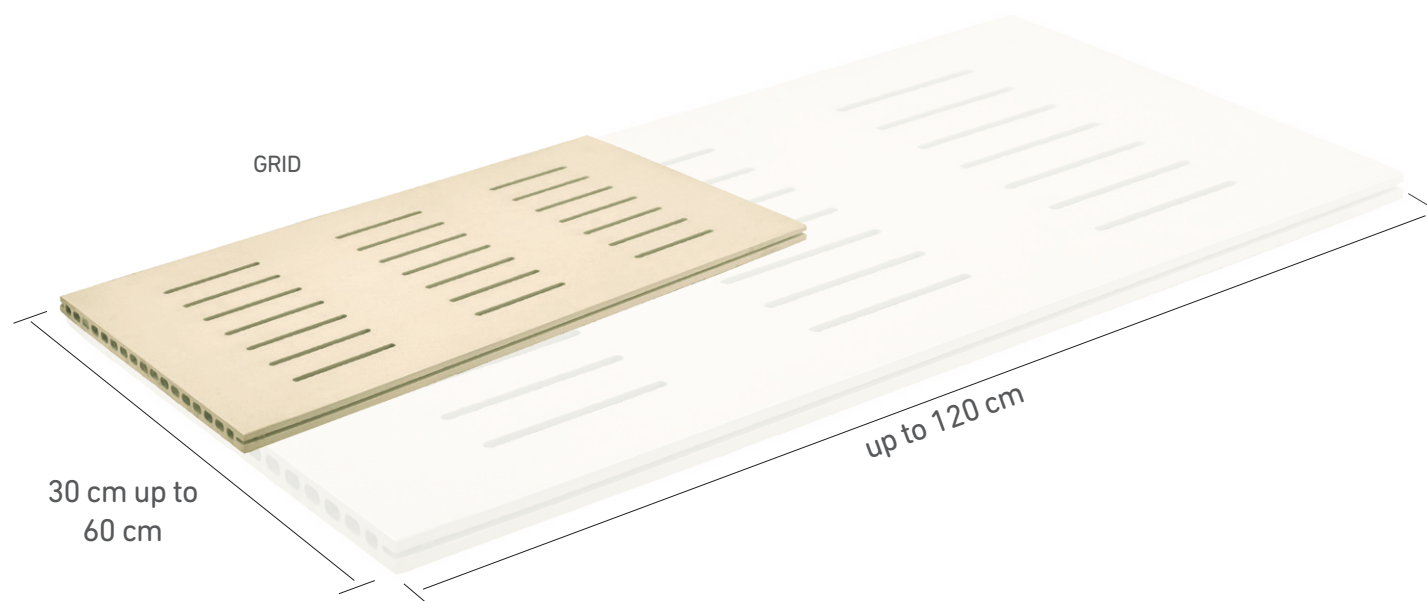

GRID

rejilla / grille

La pieza de rejilla Frontek permite mantener la línea estética de la fachada en zonas donde es necesaria la ventilación, permitiendo una buena circulación del aire. Se puede fabricar en toda la gama de modelos facilitando una óptima integración arquitectónica.

The Frontek grille piece allows the aesthetic line of the façade to be maintained in areas where ventilation is necessary, allowing good air circulation. It can be manufactured in the full range of models, facilitating optimum architectural integration.

La pièce de grille Frontek permet de maintenir la ligne esthétique de la façade dans les zones où la ventilation est nécessaire, en permettant une bonne circulation de l'air. Il peut être fabriqué dans toute la gamme de modèles, ce qui facilite une intégration architecturale optimale.

REHABILITATION

REHABILITACIÓN | RÉHABILITATION

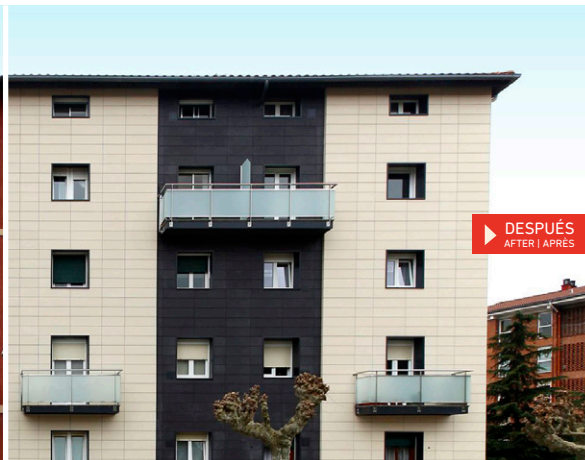
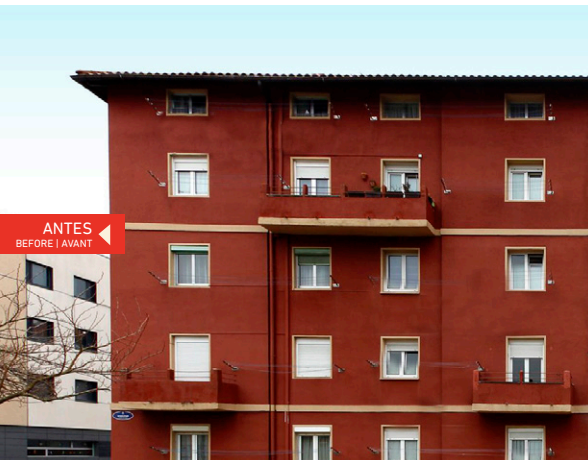

Spain, San Sebastián
Residential
building



AZABACHE



ICEBERG

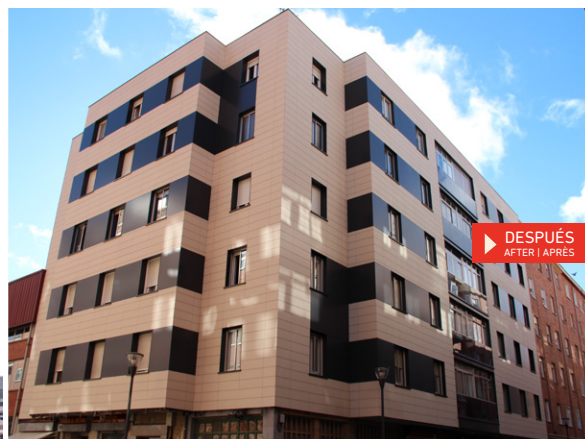

Spain, Burgos
Residential
building



AZABACHE



ICEBERG



Spain, Madrid
Residential
building



AZABACHE



S130

REHABILITATION

El sistema de fachada ventilada Frontek ofrece unas ventajas y condiciones especiales que hace de él una solución ideal para la rehabilitación de edificios. Mejora la eficiencia energética de los edificios en las que se utiliza gracias a la eliminación de puentes térmicos. Otra de sus grandes ventajas es la rapidez de ejecución, ya que aporta una renovación estética que no necesitará mantenimientos, evitando la aparición de las antiguas humedades. Como permite la instalación de aislantes térmicos por el exterior del edificio, aumenta la **eficiencia energética del edificio** y ofrece un **mayor aislamiento acústico**.

The Frontek ventilated facade system offers special advantages and conditions that make it an ideal solution for building renovation. It improves the energy efficiency of the buildings in which it is used thanks to the elimination of thermal bridges. Another of its great advantages is the speed of execution, since it provides an aesthetic renovation that will not require maintenance, avoiding the appearance of old dampness. As it allows the installation of thermal insulation on the outside of the building, it **increases the energy efficiency** of the building and offers **greater acoustic insulation**.

Le système de façade ventilée Frontek offre des avantages et des conditions particulières qui en font une solution idéale pour la rénovation des bâtiments. Il améliore l'efficacité énergétique des bâtiments dans lesquels il est utilisé grâce à l'élimination des ponts thermiques. Un autre de ses grands avantages est la rapidité d'exécution, car il permet une rénovation esthétique qui ne nécessitera pas d'entretien, évitant ainsi l'apparition de l'ancienne humidité. Comme il permet l'installation d'une isolation thermique à l'extérieur du bâtiment, il augmente l'efficacité énergétique du bâtiment et offre une meilleure isolation acoustique.

Spain,
Baracaldo
Residential
building



CANYON



ICEBERG



Spain, Málaga
Obal Hotel



S109



QUALITY CONTROL

CONTROL DE CALIDAD | CONTRÔLE DE LA QUALITÉ



QUALITY CONTROL

Control de producción

VENATTO DESING S.L. dispone de un sistema de control de producción en planta basado en las especificaciones del Reglamento Europeo nº 305/2011. De acuerdo con sus directrices, se mantiene el cumplimiento de los procedimientos específicos de los registros y controles realizados sobre lo siguiente:

- Materias primas: control de las materias primas, control de la extrusión, control de la molienda, control del secado y la cocción
- Producto final: inspección y pruebas de los paneles.

Todos los controles de inspección y ensayo se incluyen regularmente en los registros según el Manual de Control de Producción de la Planta (CPF). Los controles del producto final se realizan según la norma UNE EN 14411.

La fiabilidad de nuestro sistema Frontek viene avalada por el Documento de Idoneidad Técnica (DIT) otorgado por el Instituto "Eduardo Torroja" para certificar los resultados favorables obtenidos en sus laboratorios, así como por los buenos resultados presentados por la fachada ventilada Frontek en los distintos proyectos en los que se ha instalado.

Production control

VENATTO DESING S.L. has a plant production control system based on the specifications of European Regulation No.305/2011. In accordance with its guidelines, compliance is upheld with the specific procedures for registers and controls undertaken involving the following:

- Raw materials: control of raw materials, control of extrusion, control of milling, control of drying and firing.
- End product: inspection and testing of panels.

All inspection and testing controls are regularly included in registers as per the Plant Production Control Manual (CPF). End product controls are conducted as per Standard UNE EN 14411.

The reliability of our Frontek system is backed up by the Technical Approval Document (DIT) awarded by the "Eduardo Torroja" Institute to certify the favourable results obtained in its laboratories, and also by the good results presented by the Frontek ventilated façade in the various projects in which it has been installed.

Contrôle de production

VENATTO DESING S.L. dispose d'un système de contrôle de production en usine basé sur les spécifications du règlement européen N° 305/2011. Conformément à ses directives, des procédures spécifiques pour les enregistrements et les contrôles effectués sur les éléments suivants sont respectées :

- Matières premières : contrôle des matières premières, contrôle de l'extrusion, contrôle de la mouture, contrôle du séchage et de la cuisson.
- Produit fini: inspection et test sur plaques.

Tous les contrôles d'inspection et d'essai sont consignés périodiquement, comme le prévoit le manuel de contrôle de production de l'usine. Les contrôles du produit fini sont effectués selon la norme UNE EN 14411.

La fiabilité du système Frontek est confirmée par les bons résultats obtenus dans de multiples projets où il a été installé avec la plus grande efficacité. Greco Gres Internacional est en possession du Document d'Agrément Technique, qui est délivré par l'Institut « Eduardo Torroja » à chacun des systèmes.

CERTIFICATES

CERTIFICADOS | CERTIFICATS

| Compromiso con la calidad y el desarrollo sostenible

Frontek cuenta con los más prestigiosos certificados que acreditan la calidad de nuestros procesos productivos y avalan nuestro compromiso con la sostenibilidad. Nuestro compromiso no solo se fundamenta en el respeto de la normativa vigente. Afrontamos un compromiso con la sociedad, basado en la realización de un producto que contribuya a proteger el medio ambiente, haciendo un uso racional de la energía.

Nos preocupamos de las personas y por eso cuidamos el medio ambiente y desarrollamos productos que mejoren el confort y la seguridad de los trabajadores que fabrican nuestros productos, los empleados que construyen los edificios y también de las personas que van a habitar esos edificios.

Queremos dejar un mundo mejor a las futuras generaciones. Invertimos nuestros recursos en una mejora continua de nuestros procesos productivos y en la investigación para el desarrollo de nuevos productos. Escuchando a nuestros clientes y liderando nuevos sistemas que nos ayuden a mejorar la calidad que viene avalada por los más exigentes certificados internacionales.

Nos tomamos muy en serio la confianza que nuestros clientes han depositado en nuestros productos. No escatimamos esfuerzos para acreditar la calidad y seguridad de nuestros productos.

| Committed to quality and sustainable developme

Frontek holds the most prestigious certificates that certify the quality of our production processes and endorse our commitment to sustainability. Our commitment is not based solely on compliance with current regulations. We have a commitment to society, focussed on creating a product that helps protect the environment, makes a rational use of energy.

We care about people and this is why we look after the environment and develop products that improve the comfort and safety of the workers who make these products, the employees who build the buildings and also the people who will live in these homes.

We want to leave behind a better world for future generations. We invest our resources into the ongoing improvement of our production processes and into research for the development of new products. We listen to our customers and pioneer new systems that help us improve the quality endorsed by the most discerning international certificates.

We take our customers' trust very seriously. We spare no efforts on accrediting the quality and safety of our products.

| Engagement en matiere de qualite et de developpement durable

Frontek possède les certificats les plus prestigieux qui accréditent la qualité de nos processus de production et avalisent notre engagement en matière de développement durable. Notre engagement ne repose pas uniquement sur le respect de la réglementation en vigueur. Nous sommes engagés envers la société, sur la base de la réalisation d'un produit qui contribue à la protection de l'environnement, à l'utilisation rationnelle de l'énergie.

Nous nous soucions des individus et c'est pourquoi nous nous préoccuons de l'environnement et développons des produits qui améliorent le confort et la sécurité des travailleurs qui fabriquent nos produits, des employés qui construisent les bâtiments et aussi des personnes qui vivront dans ces bâtiments.

Nous voulons laisser un monde meilleur aux générations futures. Nous investissons nos ressources dans une amélioration continue de nos processus de production et dans la recherche pour le développement de nouveaux produits. L'écoute de nos clients et la mise en place de nouveaux systèmes nous aident à améliorer la qualité, garantie par les certificats internationaux les plus exigeants.

Nous prenons très au sérieux la confiance que nos clients ont placée dans nos produits. Nous ne ménages aucun effort pour prouver la qualité et la sécurité de nos produits.



CERTIFICATES

CERTIFICADO DE CONTROL DE PRODUCCIÓN EN FÁBRICA
1219 – CPR – 0102
 CERTIFICATE OF CONFORMITY OF FACTORY PRODUCTION CONTROL

En cumplimiento del Reglamento (UE) N.º 305/2011 del Parlamento Europeo y del Consejo de 9 de marzo de 2011 (Reglamento de Productos de Construcción),
 In compliance with the Regulation (EU) 305/2011 of the European Parliament and of the Council of 9 March 2011 (the Construction Products Regulation).

| | |
|--|--|
| Este Documento certifica que: <i>This Document certifies:</i> | El IETcc realiza la evaluación y verificación de la constancia de las prestaciones de acuerdo con el sistema 2+ descrito en el cap. 4 de la Evaluación Técnica Europea (ETE) 15/0916 del 23/11/2015 <i>IETcc undertakes the assessment and verification of constancy of performances under system 2+ in relation to the requirements contained in the section 4 of the European Technical Assessment (ETA) 15/0916 issued on 23/11/2015</i> |
| Nombre comercial: <i>Trade name:</i> | FRONTEK PLUS y FRONTEK OMEGA PLUS |
| Familia a la que pertenece el producto de construcción: <i>Product family to which the construction product belongs:</i> | Kits de revestimiento exterior de fachadas <i>Kits for external wall claddings</i> |
| Planta de fabricación: <i>Manufacturing plant:</i> | GRECO GRES INTERNACIONAL, S.L. Avda. Castilla La Mancha, 1 45240 ALAMEDA DE LA SAGRA (Toledo) ESPAÑA |
| Beneficiario de ETE: <i>ETA holder:</i> | GRECO GRES INTERNACIONAL, S.L. Avda. Castilla La Mancha, 1 45240 ALAMEDA DE LA SAGRA (Toledo) ESPAÑA www.grecogres.com |

Este Certificado es válido durante el año 2022 a condición de que la ETE 15/0916 del 23/11/2015 no sea cancelada o modificada⁽¹⁾; además de que las tareas de evaluación y verificación de la constancia de las prestaciones (EVC/P) realizadas por el IETcc como Organismo Notificado sobre el cumplimiento de las condiciones relativas a la producción y al control de producción en fábrica, establecidas en el ámbito del Anexo V del Reglamento (UE) N.º 305/2011 resulten favorables, y siempre que éstas condiciones no se modifiquen significativamente.

⁽¹⁾ La validez de este Certificado se puede comprobar mediante consulta de la página web <https://dit.ietcc.csic.es/Documentos> o bien, mediante correo electrónico dirigido a gestion@ietcc.csic.es

En nombre y representación del IETcc-CSIC
 On behalf of IETcc-CSIC

El Director IETcc-CSIC
 The IETcc Director

De conformidad con lo especificado en los artículos 8 y 9 del Reglamento (UE) N.º 305/2011 de Productos de construcción, el fabricante podrá incorporar el Marcado CE a sus productos.
 In accordance with what is specified in articles 8 and 9 of Regulation (EU) No. 305/2011 on Construction Products, the manufacturer may incorporate the CE Marking on its products.

CE Organismo Notificado 1219
 Notified Body 1219

CERTIFICADO FAVORABLE DE SEGUIMIENTO DE 2021
 2021 FAVOURABLE SURVEILLANCE CERTIFICATE

En cumplimiento del Decreto número 3652/1963, de 26 de diciembre de la Presidencia del Gobierno y por la Orden n.º 1265 de 23 de diciembre de 1986, del Ministerio de Relaciones con las Cortes, para la evaluación técnica de la aptitud de empleo de los nuevos materiales, Sistemas y Procedimientos de Construcción para la Concesión del DOCUMENTO DE IDONEIDAD TÉCNICA y según en el Reglamento para el Seguimiento del Documento de Idoneidad Técnica (DIT) de 28 octubre de 1998.

In compliance with Decree number 3652/1963, of 26th of December, of the Presidency of the Government and by the Order No. 1265 of 23rd December 1986, of the Department of Relations by the Spanish Parliament, for the technical evaluation of the aptitude of use of the new materials, Systems and Procedures for the issuing of Technical Agreement (DIT), and according to the Surveillance Regulation for the Technical Agreement (DIT), version October 28th, 1998.

DOCUMENTO DE IDONEIDAD TÉCNICA: N.º 527P/17

| | |
|--------------------------------------|--|
| Área genérica/Usos previstos: | Sistema de revestimiento de fachadas ventiladas con placas cerámicas |
| Nombre comercial: | FRONTEK PLUS FRONTEK OMEGA PLUS |
| Beneficiario: | GRECO GRES INTERNACIONAL, S.L |
| Sede social: | Avda. Castilla La Mancha, 1 45240 Alameda de la Sagra (Toledo) ESPAÑA Tif. (+34) 925 50 05 39 Fax: (+34) 925 50 02 70 http://www.grecogres.com |

La Dirección del IETcc, en conformidad con el Reglamento para el Seguimiento del DIT de octubre de 1998 y el contrato n.º 21.303, realizado con la empresa arriba mencionada, y examinado el informe de inspección correspondiente al año 2021, para el DIT n.º 527P/17

Hace constar, la conformidad con las especificaciones y exigencias establecidas en dicho DIT y, por tanto, expide el presente **CERTIFICADO FAVORABLE DE SEGUIMIENTO, válido durante el 15/03/2022** ⁽¹⁾.

⁽¹⁾ La validez del Certificado se puede comprobar mediante consulta de la página web <https://dit.ietcc.csic.es/Documentos> o bien, mediante correo electrónico dirigido a gestion@ietcc.csic.es

The validity of this Certificate can be checked by consultation of web page <https://dit.ietcc.csic.es/Documentos> or through email addressed to gestion@ietcc.csic.es

En nombre y representación del IETcc:
 On behalf of IETcc:

Firmado por CASTILLO TALAUEVA ANGEL - DNI 52507808P
 Fecha: 24/02/2022 10:59:05 CET

Director IETcc-CSIC

Certification
 Awarded to

GRUPO GRECO GRES INTERNACIONAL S.L.

AVDA. CASTILLA LA MANCHA, 1 PARCELA 16933 - 45240 - ALAMEDA DE LA SAGRA - TOLEDO - ESPAÑA

Bureau Veritas Certification certifies that the Management System has been audited and found to be in accordance with the requirements of standard:

STANDARD

ISO 9001:2015

Scope of certification:

DISTRIBUTION OF KLINKER PAVERS, KLINKER FACED BRICKS, EXTRUDED STONWARE, EXTRUDED PORCELAIN, AND ITS SPECIAL PIECES.

| | |
|---------------------------------|-------------|
| Certificate Number: | ESI217175-1 |
| Original approval date: | 04-02-2019 |
| Certification/Renovation Audit: | 18-01-2022 |
| Expiry date of previous cycle: | 16-02-2022 |
| Effective date: | 17-02-2022 |
| Certificate expiration date: | 16-02-2025 |

ORGANIZATION PREVIOUSLY CERTIFIED UNDER THE NAME GRECO GRES INTERNACIONAL S.L. SINCE 21-11-2000

This certificate is valid, subject to the general and specific terms and conditions of certification services

Bureau Veritas Iberia S.L.
 C/Valperillo Primera 22-24, Edificio Caoba, 28108 Alcobendas - Madrid, España

ENAC
 CERTIFICACION EUROPEA

Certification
 Awarded to

GRUPO GRECO GRES INTERNACIONAL S.L.

AVDA. CASTILLA LA MANCHA, 1 PARCELA 16933 - 45240 - ALAMEDA DE LA SAGRA - TOLEDO - ESPAÑA

Bureau Veritas Certification certifies that the Management System has been audited and found to be in accordance with the requirements of standard:

STANDARD

ISO 14001:2015

Scope of certification:

DISTRIBUTION OF KLINKER PAVERS, KLINKER FACED BRICKS, EXTRUDED STONWARE, EXTRUDED PORCELAIN, AND ITS SPECIAL PIECES.

| | |
|---------------------------------|-------------|
| Certificate Number: | ESI217175-1 |
| Original approval date: | 16-03-2020 |
| Certification/Renovation Audit: | 18-01-2022 |
| Expiry date of previous cycle: | 15-03-2023 |
| Effective date: | 17-02-2022 |
| Certificate expiration date: | 16-02-2025 |

This certificate is valid, subject to the general and specific terms and conditions of certification services

Bureau Veritas Iberia S.L.
 C/Valperillo Primera 22-24, Edificio Caoba, 28108 Alcobendas - Madrid, España

ENAC
 CERTIFICACION EUROPEA

CERTIFICATES



THOMAS BELL-WRIGHT INTERNATIONAL CONSULTANTS
 In accordance with UKAS accreditation to ISO 17065
 Certification is Hereby Granted
 to
Grupo Greco Gres Internacional S.L
*Avenida Castilla La Mancha 1,
 45240 Alameda De La Sagra, Toledo, Spain*
 for
**"Frontek" 19.5 mm thick Porcelain Ceramic Tiles
 Non-Loadbearing Façade System**
 Test Method: NFPA 285-2012 Edition
 (System Designation: N013000-19)

which, subject to limitations described on the following pages and continued listing on www.tbwcert.com, complies with Product Certification Scheme SDO3 Exterior Wall Assemblies, Curtain Walls, Building Materials, Products, & Assemblies

In witness whereof, this Certificate is issued this 19th day of August 2021

 Sandy Dweik
 Chief Executive Officer

 Nicholas Purcell
 Director of Certification

Certificate Number: TBW0300356
 Initial registration: August 19, 2018 Issued: August 19, 2021 Expiration: August 18, 2024
 File Name: VE060_CRT_SD03FP_(f) Issue 2

This certificate and schedules are held in force by regular Factory Inspectors by Thomas Bell-Wright International Consultants (TBWIC). Refer to www.tbwcert.com or contact TBWIC Certification Division to validate the current status of Certification. This certificate remains the property of Thomas Bell-Wright International Consultants, PO Box 28388, Dubai, UAE. Tel: +971 4 1213777, Email: certification@bell-wright.com www.bell-wright.com
 This document must not be reproduced, except in its entirety and with the express permission of Thomas Bell-Wright International Consultants. © 2021 Scheme Certificate Issue 7 issued Feb 2020

دولة الامارات العربية المتحدة
 وزارة الداخلية
 المديرية العامة للسلامة المدنية
 لجنة اعتماد المختبرات العلمية
 وبيوت الخبرة ومعاهد التدريب

 United Arab Emirates
 Ministry of Interior
 Civil Defense G.H.Q.
 Fire International Lab & House
 Of Expertise & Training Center
 Approval Committee

Date: 13/05/2022

CERTIFICATE OF COMPLIANCE

This certificate of compliance validates the following

| | | | |
|--|--------------|--------------------|------------|
| TEST REPORT NUMBER <small>"Assessment Reports" are not acceptable</small> | 21/24650-905 | CERTIFICATE NUMBER | APP- 1473 |
| DATE OF ISSUE | 08/04/2021 | DATE OF ISSUE | 13/05/2022 |
| DATE OF EXPIRY | --- | DATE OF EXPIRY | 30/06/2023 |

Manufacturer details

| | | | |
|--|---|---------------------|---|
| NAME OF FACTORY/ MANUFACTURER | VENATTO DESIGN S.L. | NAME OF THE BRAND | VENATTO |
| FACTORY ADDRESS / REGION <small>(STREET / TOWN / CITY / COUNTRY)</small> | Avda. Castilla - La Mancha, 1 45240 Alameda de la Sagra, (Toledo) SPAIN | MODEL / NO | FRONTEK VENTILATED FAÇADE SYSTEM |
| WEBSITE | www.grecogres.com | LOGO ON THE PRODUCT |  |
| TEL | +34 925 50 00 54 | EMAIL | luis_d@grecogres.com |

 لجنة اعتماد المختبرات العلمية وبيوت الخبرة ومعاهد التدريب

LGAI Technological Center, S.A. (APPLUS)
 Carrissos UAB - Ronda de la Font del Carme s/n
 08100 Bellaterra (Barcelona)
 T: +34 93 852 22 02
 C.F. A: 61307482
www.appluslaboratories.com

Applus⁺

FIRE SAFETY CERTIFICATION

FIRE PERFORMANCE

No. **APPF-1473**

LGAI TECHNOLOGICAL CENTER S.A. (APPLUS), according to the requirements of the SPC-117 certifies the Fire Performances following the Classification and Testing standard for:

| | |
|--------------------------------------|--|
| Product | Ventilated façade system: "FRONTEK PLUS VENTILATED FAÇADE SYSTEM" |
| Company | GRUPO GRECO GRES INTERNACIONAL, S.L. AVDA. CASTILLA - LA MANCHA, 1 45240 ALAMEDA DE LA SAGRA (TOLEDO) SPAIN |
| Manufactured | VENATTO DESIGN S.L. AVDA. CASTILLA - LA MANCHA, 1 45240 ALAMEDA DE LA SAGRA (TOLEDO) SPAIN |
| Classification and testing standards | EN-ISO 1182:2010: "Fire reaction tests for construction products. Non-combustibility test". EN ISO 1716:2010: "Fire-reaction Tests of construction materials. Determination of combustion heat." EN 13501-1:2018: "Fire classification of construction products and building elements. Part 1: Classification using data from reaction to fire tests". |
| Product Details and Test Report | Check at the technical annex report nº 17-14890-1532-1 M1 and nº 21/24650-905-2 |



SPC-117
APPF-1473
Fire Safety Certification

LGAI has performed the product initial tests and the initial assessment of the management system. Periodically, the entity does a follow-up assessment of the management system.
Valid until 30th June 2023
 Renovation / Modification of the initial certificate issued on 25th June 2021
 Bellaterra, 13th May 2022

 Xavier Ruiz Peña
 Product Conformity B. U., Managing Director



You can check the validity of this certificate on our website: www.appluslaboratories.com/certified_products

This document is not valid without its technical annex, whose number coincides with the number of certificate.

 ENAC
 CERTIFICACION
 ESTE PAIS

Page 1 / 2



CERTIFICATE FOR CHINA COMPULSORY PRODUCT CERTIFICATION

CERTIFICATE NO.: 2009012102378368
NAME AND ADDRESS OF THE APPLICANT
 GRUPO GRECO GRES INTERNACIONAL S.L.
 Avda. Castilla la Mancha, NO. 1, Alameda de la Sagra, Toledo, Spain
NAME AND ADDRESS OF THE MANUFACTURER
 GRUPO GRECO GRES INTERNACIONAL S.L.
 Avda. Castilla la Mancha, NO. 1, Alameda de la Sagra, Toledo, Spain
NAME AND ADDRESS OF THE FACTORY
 GRUPO GRECO GRES INTERNACIONAL S.L.
 Avda. Castilla la Mancha, NO. 1, Alameda de la Sagra, Toledo, Spain
PRODUCT CLASSIFICATION AND SERIES NAME
 Porcelain Tiles (Radioactivity Level: A
 Porcelain Tiles Series (See Appendix)

THE STANDARDS AND TECHNICAL REQUIREMENTS FOR THE PRODUCTS
 GB6566-2010
 This is to certify that the above mentioned product(s) complies with the requirements of implementation rules for compulsory certification (REF NO.CNCA-C21-01-2014).
 Valid from: Aug. 07, 2019 Valid until: Aug. 07, 2024
 The validity of the certificate is subject to positive result of the regular follow up inspection by issuing certification body until the expiry date.
 Date of original issued: Dec. 02, 2009
 The certificate information is available through CNCA's website: www.cnca.gov.cn

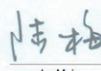

President: 
 Lu Mei



CHINA QUALITY CERTIFICATION CENTER
http://www.cqc.com.cn Section 9, No. 188, Nanshuan Xilu, Beijing 100070 P.R. China Tel: +86 108386666

Q 2379386

Приложение к ТС № 6600-22

ФЦС
ФЕДЕРАЛЬНОЕ АВТОНОМНОЕ УЧРЕЖДЕНИЕ
«ФЕДЕРАЛЬНЫЙ ЦЕНТР НОРМИРОВАНИЯ, СТАНДАРТИЗАЦИИ
И ТЕХНИЧЕСКОЙ ОЦЕНКИ СООТВЕТСТВИЯ В СТРОИТЕЛЬСТВЕ»
(ФАУ «ФЦС»)
г. Москва, Фуркасовский пер., д. 6

ЗАКЛЮЧЕНИЕ

Техническая оценка пригодности для применения в строительстве
«ПАНЕЛИ КЕРАМИЧЕСКИЕ МАРКИ frontek ТИПОВ frontek II frontek Omega»

ИЗГОТОВИТЕЛЬ GRUPO GRECO GRES INTERNACIONAL, S.L. (Испания).
Avenida de Castilla - La Mancha, 1, 45240, Alameda de la Sagra - Toledo, Spain

ЗАЯВИТЕЛЬ GRUPO GRECO GRES INTERNACIONAL, S.L. (Испания)
Avenida de Castilla - La Mancha, 1, 45240, Alameda de la Sagra - Toledo, Spain
Тел.: + 34 925500054; e-mail: archtrends@grecogres.com

Оценка пригодности продукции указанного наименования для применения в строительстве проведена с учетом обязательных требований строительных, санитарных, пожарных, экологических, а также других норм безопасности, утвержденных в соответствии с действующим законодательством, на основе документации и данных, представленных заявителем в обоснование безопасности продукции для применения по указанному в заключении назначению.

Всего на 9 страницах, заверенных печатью ФАУ «ФЦС».

И.о. директора ФАУ «ФЦС»  А.В. Копытин

27 июня 2022 г.

1

В подлинности настоящего документа можно удостовериться по тел.: (495) 133-01-57 (доб.108), www.faufcc.ru

ES ICC EVALUATION SERVICE

ICC-ES Evaluation Report **ESR-4274**
Reissued May 2021
This report is subject to renewal May 2023.

www.iccs.org | (800) 423-6587 | (562) 699-0543 A Subsidiary of the International Code Council®

DIVISION: 07 00 00—THERMAL AND MOISTURE PROTECTION
Section: 07 42 20—Wall Panels
Section: 07 42 63—Fabricated Wall Panel Assemblies
Section: 07 44 23—Ceramic Tile Faced Panels

REPORT HOLDER:
GRUPO GRECO GRES INTERNACIONAL, S.L.

EVALUATION SUBJECT:
FRONTEK PLUS AND FRONTEK OMEGA PLUS WALL FAÇADE SYSTEMS

1.0 EVALUATION SCOPE
Compliance with the following codes:
■ 2018 and 2015 International Building Code® (IBC)
■ 2018 and 2015 International Residential Code® (IRC)
For evaluation for compliance with codes adopted by Los Angeles Department of Building and Safety (LADBS), see ESR-4274 LABC and LARC Supplement.

Property evaluated:
■ Wind resistance
■ Types I, II, III and IV construction
■ Surface burning characteristics
■ Weather Resistance
■ Interior finish

2.0 USES
Frontek Plus and Frontek Omega Plus ventilated wall façade systems are intended for use as nonload-bearing exterior wall façades on nonfire-resistance-rated buildings of any type of construction. The system may be used as a nonload-bearing exterior wall covering on nonfire-resistance-rated buildings of Type I, II, III and IV construction when installed in accordance with Section 4.4. The system is also intended for use in interior applications as part of a Class A interior wall finish.

3.0 DESCRIPTION
3.1 General:
Frontek Plus and Frontek Omega Plus wall façade systems consist of extruded ceramic tiles with a honeycomb-shaped structure and a cleat at the top and the bottom to facilitate fastening to the supporting metal substructure using supplied aluminum clips. The joints between the tiles of the wall façade system are left open. The panels are available in multiple colors and texture designs. See Figure 1.

3.2 Material:
The Frontek Plus ceramic pieces have a nominal thickness of 0.717-inch (18.5 mm), have widths up to 23.62 inches (600 mm) and lengths up to 70.87 inches (1800 mm). The Frontek Omega Plus ceramic pieces have a nominal thickness of 0.75-inch (20 mm), have a width of 12.09 inches (307 mm) and lengths up to 39.37 inches (1000 mm). Ceramic pieces have an approximate unit weight of 6.76 lb/sq ft (33 kg/m²).

3.3 Aluminum Substructure:
Clamps in accordance with Section 3.5 shall be attached to an aluminum substructure. The aluminum substructure must consist of 6063-T5 aluminum alloy T-shaped members. The shapes must be supported by aluminum brackets connected to the supporting structure.

3.4 Surface-burning Characteristics:
Frontek Plus and Frontek Omega Panels, when tested in accordance with ASTM E84, have a flame-spread index of 25 or less and a smoke-developed index of 450 or less.

3.5 Stainless Steel Clamps:
The Frontek Plus and Frontek Omega Plus ceramic pieces are attached to the aluminum substructure using stainless steel clamps. The clamps are fastened to the substructure using two No. 8 stainless steel self-drilling screws. The clamps come in two configurations: staking clamp used at the top and bottom courses and double clamp used at intermediate courses of ceramic pieces. The clamps are inserted into the cleat of the tile (ceramic piece). See Figure 2.

4.0 DESIGN AND INSTALLATION
4.1 General:
Frontek Plus and Frontek Omega Plus wall façade systems must be installed over wall assemblies capable of supporting the imposed loads, including, but not limited to, transverse wind loads. The substructure must be securely fastened to the supporting wall with corrosion-resistant fasteners that are compatible with the wall assembly substrate.

4.2 Design:
The allowable wind loads for Frontek Plus and Frontek Omega Plus wall façade systems are given in Table 1 and for the attachment of the substructure to the underlying wall must equal or exceed the design uniform transverse wind loads determined in accordance with IBC Chapter 16 or IRC

ICC-ES Evaluation Reports are not to be construed as representing architects or any other entities not specifically addressed; nor are they to be construed as an endorsement of the subject of the report or a recommendation for its use. There is no warranty by ICC Evaluation Service, LLC, express or implied, as to any building or other matter in this report, or as to any products covered by the report.

Copyright © 2021 ICC Evaluation Service, LLC. All rights reserved. Page 1 of 8

SASO
Saudi Standards, Metrology and Quality Org.

شهادة ترخيص باستعمال علامة الجودة
License For Use of The Quality Mark

رقم الترخيص: 20200154021

SASO certifies that it has granted the right to use (SASO) quality mark on the following products, after fulfilling the required requirements according to the related normative references:

| | | | |
|------------------------------|--|-------------------|------------------|
| The Establishment: | GRUPO GRECO GRES INTERNACIONAL S.L. | التأسيس: | |
| The Establishment's Address: | Avda. Castilla - La Mancha, 1 - 45240 Alameda de la Sagra - Toledo - Spain | عنوان المنشأة: | |
| Production Line Location: | Avda. Castilla - La Mancha, 1 - 45240 Alameda de la Sagra - Toledo - Spain | موقع خط الإنتاج: | |
| Normative References: | SASO ISO 13006/2018 اللائحة الفنية لمواد البناء - الجزء الرابع | المراجع القياسية: | |
| The Trade Mark: | Frontek | العلامة التجارية: | |
| The Product: | بلاط الموزايك | المنتج: | المصنوع في الصين |
| Date of Granting: | 2020/08/18 | تاريخ المنح: | |
| Date of Renewal: | | تاريخ التجديد: | |
| Date of Expiry: | 2023/06/17 | تاريخ الانتهاء: | |

للمحافظة العامة للجودة
Vice Governor of Conformity and Quality Affairs

المهندس/ سعود بن راشد العسكر
Eng. Saud R. AlAskar

This certificate shall be subject to the relevant laws and regulations of Saudi Arabia and any instructions or amendments issued by SASO, during its validity.

تخضع هذه الشهادة خلال مدة صحتها للأحكام والالتزامات المتعلقة باللائحة الفنية السعودية وأي تعليمات أو تعديلات الصادرة عنها.

This SASO holder (owner) may not verify this certificate or any other technical specifications.
Any change or modification to this certificate will affect its validity.
For more information, please contact the SASO.
SASO (SASO) Ltd. - 106611-023066

التأكد من صحة هذه الشهادة من خلال التحقق من شروط وثائق المواصفات القياسية.
أي تغيير أو تعديل لهذه الشهادة سيؤثر على صحتها.
لمزيد من المعلومات، يرجى الاتصال بالمعهد السعودي للمواصفات والجودة.
رقم الترخيص: 20200154021
تاريخ الانتهاء: 2023/06/17

GlobalEPD
A VERIFIED ENVIRONMENTAL DECLARATION

AENOR
Confia

Baldosas cerámicas.
Gres Porcelánico (clasificación
A1a según UNE-EN 14411: 2016)

Fecha de emisión: 2021-12-15
Fecha de revisión: 2022-10-18
Fecha de expiración: 2026-12-14

La validez declarada está sujeta al registro y publicación en www.aenor.com

Código de Registro: GlobalEPD EN 17160 - 005 rev1

GRUPO GRECO GRES
GRUPO GRECO GRES INTERNACIONAL, S.L.



TECHNICAL DATA

DATOS TÉCNICOS | DONNÉES TECHNIQUES

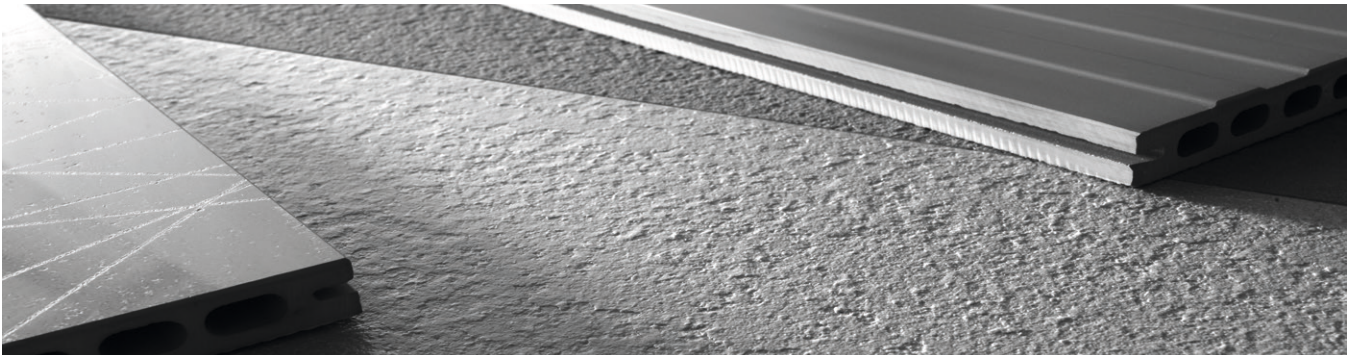

NOTA: Estos datos técnicos corresponden a los modelos y formatos estándar. Para piezas metálicas y piezas especiales solicitar información al departamento de calidad.

NOTE: This technical information corresponds to the standard models and formats. For metallic and special pieces ask for information to the Quality Department.

REMARQUE : ces données techniques correspondent aux modèles et formats standard. Pour les pièces métalliques et les pièces spéciales, veuillez demander des informations au département de la qualité.



DESTONIFICADO
COLOUR VARIETY
EFFET DÉLAVÉ



RESISTENCIA A LA ABRASIÓN PROFUNDA
DEEP ABRASION RESISTANCE
RÉSISTANCE À L'ABRASION PROFONDE
UNE-EN 10545-6

<175 mm³



COEFICIENTE DE RESTITUCIÓN
RESTITUTION COEFFICIENT
COEFFICIENT DE RESTITUTION
UNE-EN 10545-5

>0,6



RESISTENCIA AL CHOQUE TÉRMICO
RESISTANCE AGAINST THERMAL SHOCKS
RÉSISTANCE AUX CHOCS THERMIQUES
UNE-EN 10545-9

Resistente/Resistant/
Résistant



RESISTENCIA AL HIELO
FROST RESISTANCE
RÉSISTANCE À LA GLACE
UNE-EN 10545-12

Resistente/Resistant/
Résistant



HIGIÉNICO: RESISTENTE A PRODUCTOS DE LIMPIEZA CON QUÍMICAS FUERTES
HYGIENIC: RESISTANCE TO CHEMICAL ETCHING
HYGIÉNIQUE: RÉSISTANCE À LA GRAVURE CHIMIQUE
UNE-EN 10545-13

Resistente/Resistant/
Résistant



COEFICIENTE DE DILATACIÓN TÉRMICA
LINEAL THERMAL EXPANSION COEFFICIENT
COEFFICIENT DE DILATATION THERMIQUE
UNE-EN 10545-8

≤9x10⁻⁶/°C



RESISTENCIA A LAS MANCHAS
RESISTENCE TO STAINING
RÉSISTANCE AUX TACHES
UNE-EN 10545-14/3-5

Resistente/Resistant/
Résistant



PESO ESPECÍFICO POR M²: 32 kg/m²
SPECIFIC GRAVITY PER M²: 32 kg/m²
POIDS SPÉCIFIQUE PAR M²: 32 kg/m²



DUREZA MOHS
SURFACE SCRATCH HARDNESS MOHS SCALE
DURETÉ MOHS
UNE-EN 67101

5-7



ABSORCIÓN DE AGUA
WATER ABSORPTION
ABSORPTION D'EAU
UNE-EN 10545-3

≤0,5%

xbacter
TECHNOLOGY

Cualquiera de nuestros productos puede ser solicitado y fabricado con la Tecnología Xbacter®, un acabado que aporta propiedades antibacterianas activas y permanentes incluso en ausencia de luz UV.

Any of our products can be requested and manufactured with Xbacter® Technology, a finish that provides active and permanent antibacterial properties even in the absence of UV light.

N'importe lequel de nos produits peut être demandé et fabriqué avec la Technologie Xbacter®, une finition qui offre des propriétés antibactériennes actives et permanentes même en l'absence de lumière UV.

TECHNICAL DATA

| CARACTERÍSTICAS TÉCNICAS TECHNICAL DATA CARACTÉRISTIQUES TECHNIQUES | | NORMA DE REFERENCIA REFERENCE STANDARD NORME DE RÉFÉRENCE |
|---|--|---|
| Manufacturing process Proceso de fabricación Procédé industriel | Pieza cerámica extrusionada fabricada en proceso de monococción Extruded ceramic tile made of single firing process Pièce en céramique extrudée fabriquée selon un processus de cuisson unique | UNE EN 14411 ISO 13006 |

| CARACTERÍSTICAS FÍSICAS PHYSICAL DATA CARACTÉRISTIQUES PHYSIQUES | UNE EN 14411 ISO STANDARD 13006 | VALORES OBTENIDOS OBTAINED VALUES VALEURS OBTENUES | NORMA DE ENSAYO TESTING STANDARD NORME D'ESSAI |
|--|--|--|---|
| Absorción de Agua Water Absorption Absorption d'eau | $E \leq 0,5\%$ | $\leq 0,5\%$ | UNE-EN ISO 10545 Parte 3 / Part 3 / Partie 3 |
| Fuerza de rotura (N) Breaking strength (N) Force de rupture (N) | ≥ 3000 N | ≥ 6000 N | UNE-EN ISO 10545 Parte 4 / Part 4 / Partie 4 |
| Resistencia al impacto (Coeficiente de Restitución) Impact Resistance Résistance aux chocs | $\geq 0,55$ | $\geq 0,65$ | UNE-EN ISO 10545 Parte 5 / Part 5 / Partie 5 |
| Resistencia a la abrasión profunda Resistance to deep abrasion Résistance à l'abrasion profonde | 275 mm ³ | ≤ 175 mm ³ | UNE-EN ISO 10545 Parte 6 / Part 6 / Partie 6 |
| Resistencia a la abrasión superficial Resistance to surface abrasion Résistance à l'abrasion de la surface | PEI 0 - 5 | PIE 3 - 5 | UNE-EN ISO 10545 Parte 7 / Part 7 / Partie 7 |
| Dilatación térmica lineal Lineal thermic dilatation Dilatation thermique linéaire | $< 9 \times 10^{-6} / ^\circ\text{C}$ | $< 9 \times 10^{-6} / ^\circ\text{C}$ | UNE-EN ISO 10545 Parte 8 / Part 8 / Partie 8 |
| Resistencia al choque térmico Thermal shock resistance Résistance aux chocs thermiques | Resiste la prueba Resist Résiste aux tests | Resiste la prueba Resist Résiste aux tests | UNE-EN ISO 10545 Parte 9 / Part 9 / Partie 9 |
| Dilatación por humedad Expansion for dampness Dilatation due à l'humidité | No exigida Not required Non obligatoire | $\leq 0,1$ mm/m | UNE-EN ISO 10545 Parte 10 / Part 10 / Partie 10 |
| Resistencia a la helada Frost resistance Résistance au gel | Resiste la prueba Resist Résiste aux tests | Resiste la prueba Resist Résiste aux tests | UNE-EN ISO 10545 Parte 12 / Part 12 / Partie 12 |
| Resistencia a productos químicos Stain resistance Résistance aux produits chimiques | Mínimo clase B Minimum class B Classe minimale B | Clase A Class A Classe A | UNE-EN ISO 10545 Parte 13 / Part 13 / Partie 13 |
| Resistencia a las manchas Stain resistance Résistance aux taches | Clase 1 a 5 Class 1 to 5 Classe 1 à 5 | Clase 3 - 5 Class 3 - 5 Classe 3 - 5 | UNE-EN ISO 10545 Parte 14 / Part 14 / Partie 14 |
| Reacción al fuego Reaction to fire Réaction au feu | No exigida Not required Non obligatoire | Clase AI Class AI Classe AI | Sin necesidad de ensayo Testing is not required Tests non nécessaires |

XBACTER

Cada uno de nuestros productos puede ser solicitado y fabricado con la tecnología Xbacter®, un acabado a base de nanopartículas de plata sometidas a altas temperaturas que proporciona propiedades antibacterianas activas y permanentes incluso en la ausencia de la luz UV.

Any of our products can be requested and manufactured with Xbacter® Technology, a finish based on silver nanoparticles subjected to high temperatures that provide active and permanent antibacterial properties even in the absence of UV light.

Chacun de nos produits peut être commandé et fabriqué avec la technologie Xbacter®, une finition à base de nanoparticules d'argent soumises à des températures élevées qui confère des propriétés antibactériennes actives et permanentes, même en l'absence de lumière UV.

Es el **tratamiento** perfecto para encimeras y otras superficies que garantizan la asepticidad, así como para fachadas en **ambientes húmedos** donde es esencial evitar el verdín.

It is a perfect **treatment** for countertops and other surfaces that guarantee asepticity, as well as for facades in **humid environments** where it is essential to avoid verdigris.

C'est le **traitement** idéal pour les plans de travail et autres surfaces qui garantissent l'asepsie, ainsi que pour les façades dans les **environnements humides** où il est essentiel d'éviter le vert-de-gris.





XBACTER

Consulta mas informacion sobre Xbacter. | More information about Xbacter. | En savoir plus sur Xbacter.



FACHADAS
FACADES
FAÇADES



ENCIMERAS
COUNTERTOPS
ENCIMERES



REVESTIMIENTOS
COATINGS
REVÊTEMENTS



Tecnología antibacteriana

Antibacterial technology

Technologie antibactérienne



Nano partículas de plata
a elevadas temperaturas

Silver nanoparticles
at high temperatures

Nanoparticules d'argent
a haute température



Propiedades permanentes

Permanent properties

Propriétés permanentes



Interiores y exteriores.
No requiere luz UV

Interiors & exteriors.
UV not required

Intérieur et extérieur.
UV non nécessaire



Proceso sostenible

Eco friendly process

Processus respectueux
de l'environnement



Certificación Jis z 2801

Jis z 2801 certification

Certification Jis z 2801



GRUPO
GRECO
GRES



ANERR
Asociación Nacional de Empresas
de Rehabilitación y Pavimentos



GlobalEPD
A VERIFIED ENVIRONMENTAL DECLARATION



ES ICC
EVALUATION
SERVICE



GRUPO GRECO GRES INTERNACIONAL S.L.
FÁBRICA, CENTRO DE OPERACIONES Y SHOWROOM
Avda. Castilla La Mancha 1,
45240 Alameda de la Sagra, Toledo (Spain)
+34 925 500 054
informacion@grecogres.com

GRECO GRES MADRID
OFICINA TÉCNICA Y SHOWROOM
Calle Espronceda, 39
28003 Madrid (Spain)
+34 919 244 429
proyectos@grecogres.com

GRECO GRES CATALUNYA
DELEGACIÓ NORT-EST, DIPÒSIT LOGÍSTIC I SHOWROOM
C/ Miquel Torelló i Pagès 40, Pol. Ind. El Pla,
08750 Molins de Rei, Barcelona (Spain)
+34 936 803 880
grecoatalunya@grecogres.com

Frontek USA
1695 Curtiss Court
La Verne, CA 91750
Tel.: +1 9149182211
Email: info@frontek-usa.com
www.frontek-usa.com

La empresa Grupo Greco Gres Internacional, S.L. se reserva el derecho de anular y modificar, total o parcialmente, cualquiera de los modelos, colores, formatos, referencias y especificaciones de este catálogo.
The management of Grupo Greco Gres Internacional, S.L. reserves the right to delete and amend, either totally or partially, any of the styles colours, shapes, sizes, references and other technical specifications contained in this catalogue.

Prohibida la reproducción total o parcial de este catálogo sin autorización expresa de Grupo Greco Gres Internacional, S.L.
The total or partial reproduction of this catalogue without prior written authorization from Grupo Greco Gres Internacional, S.L. is strictly prohibited.

La información que aparece en este folleto de publicidad es meramente informativa y carece de valor contractual.
The information contained in this advertising brochure is for information purposes only and has no contractual value.